



Ginger

Joan Gaspar

marset



Ginger 60

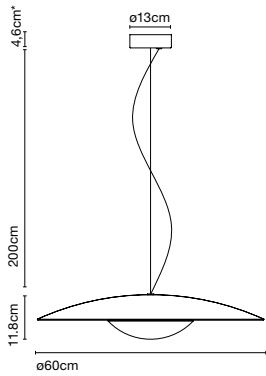

Ginger 42

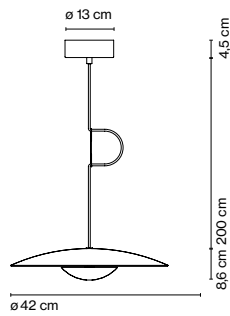

Ginger 32

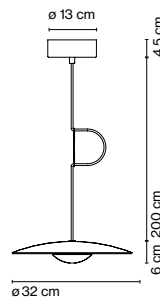

* 6,5cm (DALI)

Wood is a great ally of cozy lighting. It is a material that is hard to mold, a challenge that the Ginger collection neatly resolves. The combination of sheets of wood and paper pressed together under high pressure achieves a laminate that appears almost entirely flat.

Ginger 60

LED SMD 28,5W 700mA
2700K CRI90
Luminaire 1165lm
Lamp source 3023lm
(included)

Ginger 42

LED SMD 21,7W 700mA
2700K CRI90
Luminaire 698lm
Lamp source 2130lm
(included)

Ginger 32

LED SMD 11,5W 700mA
2700K CRI90
Luminaire 350lm
Lamp source 1066lm
(included)

- Oak
- Wenge
- Brushed brass - Brushed brass
- Brushed brass - White
- Black - White
- White - White

Black electrical cord

Recessed canopy available

Pressed wood or brushed aluminum diffuser. Injected and lacquered black metal matte aluminum dissipater.

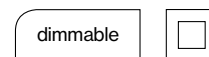

- [Download](#) Assembly Instructions
- [Download](#) Photometric Data
- [Download](#) 2D
- [Download](#) 3D
- [Download](#) Energy label

Range

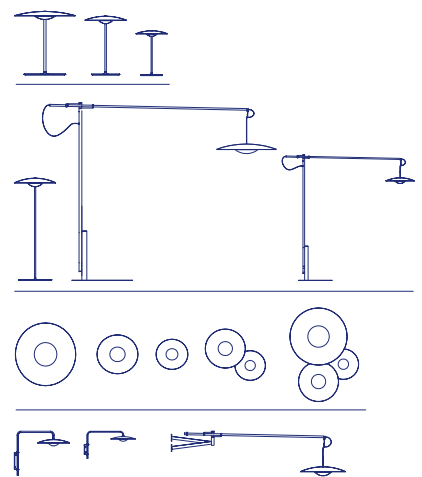



Ginger 20

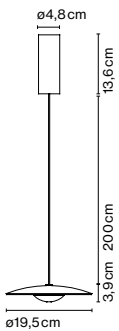

Ginger 20x3

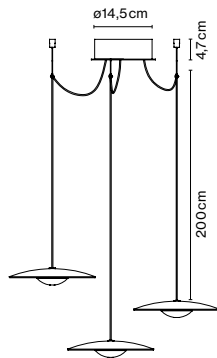

**Ginger 20x3:
Canopy accessory**

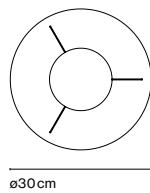

Ginger 20

LED SMD 6W 350mA
2700K CRI90
Luminaire 139lm
Lamp source 546lm
(included)

Ginger 20x3

3x LED SMD 6W 350mA
2700K CRI90
Luminaire 3x139lm
Lamp source 3x546lm
(included)

- Oak - Oak
- Wenge - Wenge
- Oak - White
- Wenge - White
- Brushed brass - Brushed brass
- Brushed brass - White
- Black - White
- White - White

Black electrical cord

Pressed wood or brushed aluminum diffuser.
Injected and lacquered black metal matte aluminum dissipater.

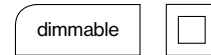

- [Download](#) Assembly Instructions
- [Download](#) Photometric Data
- [Download](#) 2D
- [Download](#) 3D
- [Download](#) Energy label

Range

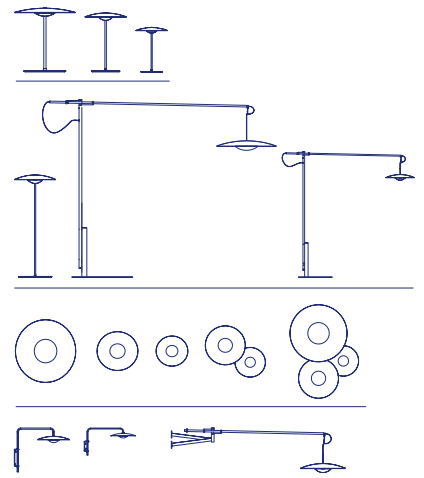

Watch the video

info@marset.com
www.marset.com

Wood is a great ally of cozy lighting. It is a material that is hard to mold, a challenge that the Ginger collection neatly resolves. The combination of sheets of wood and paper pressed together under high pressure achieves a laminate that appears almost entirely flat.

For mounted canopy installation

Take into account the total power in watts, the power of the driver, and the wire entry points of the canopy. The total wattage of the selected lamps elements cannot exceed the max wattage of the canopy's driver. Therefore, you must choose your canopy/driver by the power required. Finally, the number of lamps installed in a single canopy cannot exceed the number of wire entry points of that canopy.

Canopy 20W/ Circular

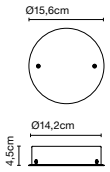

Canopy 50W/ Circular

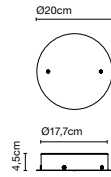

Canopy 50W/ Rectangular

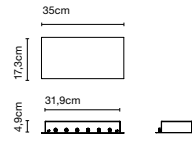

Canopy 50W/ Circular

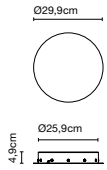

Canopy 100W/ Circular

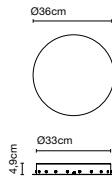

Hook accessory



Ginger 20 - 24V

LED SMD 5,2W 24V 2700K CRI90

Lamp source - 480lm

(included)

Wire entry points

Canopy 20W/ Circular	3
Canopy 50W/ Circular	5
Canopy 50W/ Rectangular	9
Canopy 50W/ Circular	9
Canopy 100W/ Circular	19

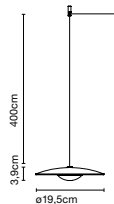

Black electrical cord

This system makes it possible to connect several suspension lamps into a single point of light, offering the absolute freedom to build with light. The Cluster accessory helps to illuminate large spaces or create compositions with the Dipping Light collection or the Ginger 20 model.

How Ginger illuminates

