



# LED-Ginger

## Joan Gaspar

marset



**LED-Ginger 60**

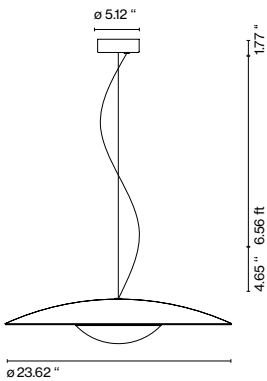

**LED-Ginger 42**

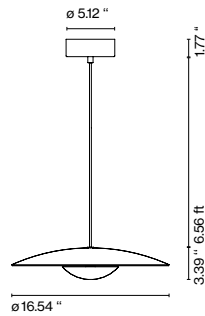

**LED-Ginger 32**

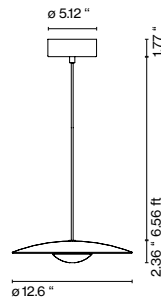

**LED-Ginger 60**

LED SMD 28W 700mA  
2700K CRI90  
Delivered Lumens 1165lm (included)  
120 V / 60 Hz

**LED-Ginger 42**

LED SMD 21W 700mA  
2700K CRI90  
Delivered Lumens 698lm (included)  
120 V / 60 Hz

**LED-Ginger 32**

LED SMD 14W 700mA  
2700K CRI90  
Delivered Lumens 350lm (included)  
120 V / 60 Hz

- Oak - White
- Wenge - White
- Brushed brass - White
- Brushed brass - White
- Black - White
- White - White

Black electrical cord

Pressed wood or brushed aluminum diffuser. Injected and lacquered black metal matte aluminum dissipater.



Dry locations only

dimmable

LED-Ginger 42 / 32  
Triac phase control dimmer  
OR  
0-10 (120-277V)

LED-Ginger 60  
Dual dimming driver  
Triac 120VAC only / 0-10V 120-277VAC

- [Download](#) Assembly Instructions
- [Download](#) Photometric Data
- [Download](#) 2D
- [Download](#) 3D

**Range**

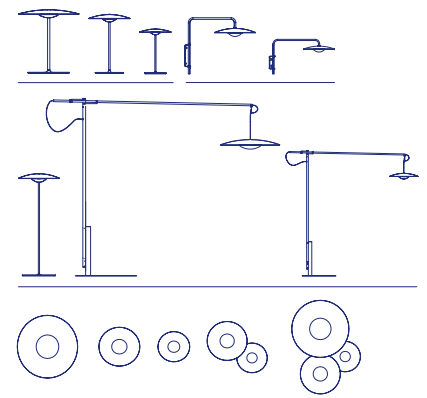

**⚠ WARNING.** California Proposition 65 Warning for California Consumers. This product can expose you to chemicals including wood dust and lead which are known to the State of California to cause cancer or birth defects or other reproductive harm. For more information go to [www.P65Warnings.ca.gov](http://www.P65Warnings.ca.gov)

**Watch the video**  
[marsetusa@marset.com](mailto:marsetusa@marset.com)  
[www.marset.com](http://www.marset.com)

Wood is a great ally of cozy lighting. It is a material that is hard to mold, a challenge that the LED-Ginger collection neatly resolves. The combination of sheets of wood and paper pressed together under high pressure achieves a laminate that appears almost entirely flat.



**LED-Ginger 20**



**LED-Ginger 20x3**

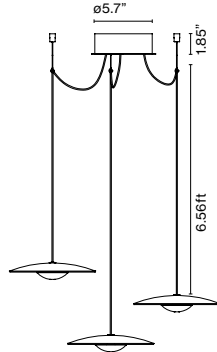

**LED-Ginger 20x3:  
Canopy accessory**

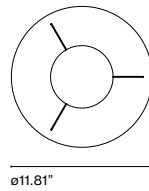

**LED-Ginger 20**

LED SMD 6W 350mA  
2700K CRI90  
Delivered Lumens - 139lm  
(included)

120 V / 60 Hz - 6W

**LED-Ginger 20x3**

3x LED SMD 6W 350mA  
2700K CRI90  
Delivered Lumens 3x 139lm  
(included)

120 V / 60 Hz - 16W

Pressed wood or brushed aluminum diffuser.  
Injected and lacquered black metal matte aluminum dissipater.



Dry locations only

dimmmable\*\*

\*\* Only Ginger 20x3 version  
0-10V / Triac phase control dimmer (Only 120V)

[Download](#) Assembly Instructions

[Download](#) Photometric Data

[Download](#) 2D

[Download](#) 3D

**Range**

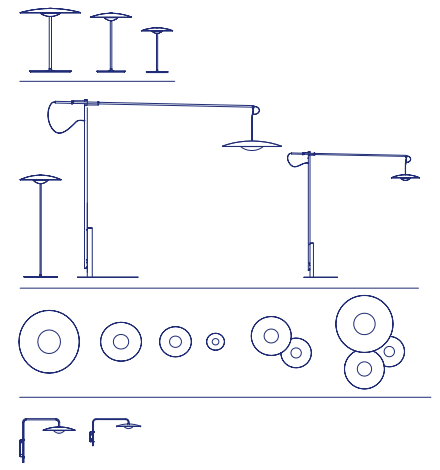

- Oak - Oak
- Wenge - Wenge
- Oak - White
- Wenge - White
- Brushed brass - Brushed brass
- Brushed brass - White
- Black - White
- White - White

Black electrical cord

**Watch the video**

marsetusa@marset.com  
www.marset.com

**⚠ WARNING.** California Proposition 65 Warning for California Consumers. This product can expose you to chemicals including wood dust and lead which are known to the State of California to cause cancer or birth defects or other reproductive harm. For more information go to [www.P65Warnings.ca.gov](http://www.P65Warnings.ca.gov)

Wood is a great ally of cozy lighting. It is a material that is hard to mold, a challenge that the LED-Ginger collection neatly resolves. The combination of sheets of wood and paper pressed together under high pressure achieves a laminate that appears almost entirely flat.

**For mounted canopy installation**

Take into account the total power in watts, the power of the driver, and the wire entry points of the canopy. The total wattage of the selected lamps elements cannot exceed the max wattage of the canopy's driver. Therefore, you must choose your canopy/driver by the power required. Finally, the number of lamps installed in a single canopy cannot exceed the number of wire entry points of that canopy.

**Canopy 20W/ Circular**

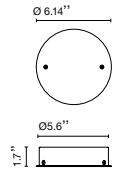

**Canopy 50W/ Circular**

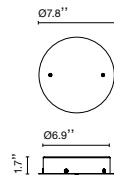

**Canopy 50W/ Rectangular**

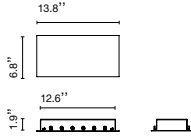

**Canopy 50W/ Circular**

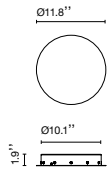

**Canopy 100W/ Circular**

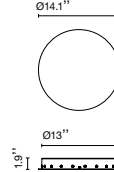

**Hook accessory**

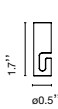

**Power**

Ginger 20 - 24V 5.2W

**Wire entry points**

Canopy 20W/ Circular	3
Canopy 50W/ Circular	5
Canopy 50W/ Rectangular	9
Canopy 50W/ Circular	9
Canopy 100W/ Circular	19

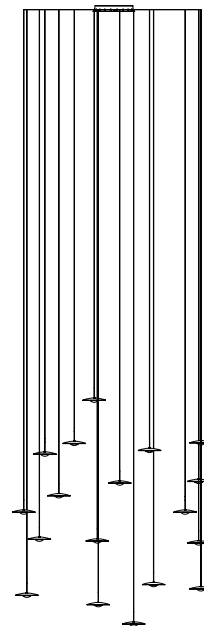

Black electrical cord

This system makes it possible to connect several suspension lamps into a single point of light, offering the absolute freedom to build with light. The Cluster accessory helps to illuminate large spaces or create compositions with the Dipping Light collection or the Ginger 20 model.

### How LED-Ginger illuminates

