



ALPHABETICAL INDEX · ÍNDICE ALFABÉTICO

A

222 · Atila A
150 · Atila
314 · Atlas

B

248 · Beta
230 · Big Mouse

C

260 · Cala IP65
76 · Cala P
104 · Camp
130 · Clea
50 · Compass
204 · Continua
224 · Cotton A
158 · Cotton M, Mini, S
112 · Cotton P, R

D

22 · Discocó
200 · Discocó A
62 · Discocó C
292 · Duna

E

252 · Espejito, espejito...

F

80 · Funiculí

L

268 · Lab
176 · Ledcompass
182 · Ledpipe, C, RSC
108 · Ledpipe P
166 · Ledtube
172 · Ledtube R
344 · Lin

M

246 · Manhattan
242 · Manhattan T5
16 · Maranga
60 · Maranga C
126 · Maranga M, S
88 · Maranga P
142 · Mercer, M, Mini
216 · Mercer A
70 · Mercer C
238 · Moma

N

296 · Nagy
304 · Neón de luz
212 · Nolita A
136 · Nolita M
100 · Nolita P
40 · Nolita Susp.
214 · Nolita Cotton A
140 · Nolita Cotton M
102 · Nolita Cotton P
44 · Nolita Cotton Susp.

O

56 · Olav
72 · Olav P

P

66 · Plaff-on!
8 · Pleat Box
116 · Polo

R

326 · R.Axis

S

54 · S2
188 · Scantling A
94 · Scantling P
122 · Scantling S
194 · Scene
232 · Silo A, C
162 · Silo S
34 · Soho Susp.
64 · Soho C
290 · Soho IP44
332 · Sq. Axis

T

2 · Tam Tam, Mini
190 · Tam Tam A
154 · Topolina
278 · Txl

V

236 · Viga Mini

Z

228 · Zoo

0-9

226 · 204

INDEX BY SECTIONS · ÍNDICE POR SECCIONES

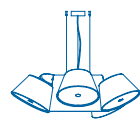
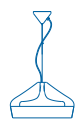
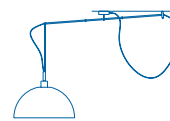
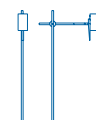
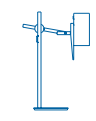
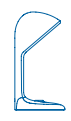
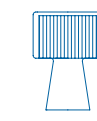
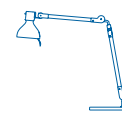
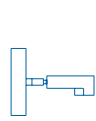
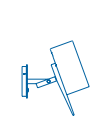
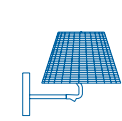
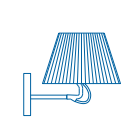
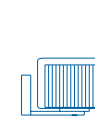
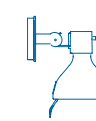
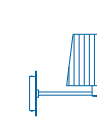
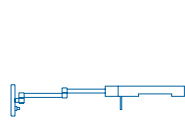
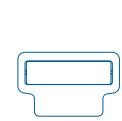
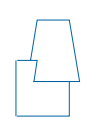
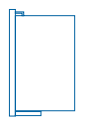
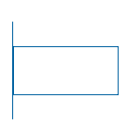
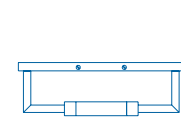
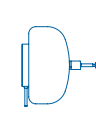
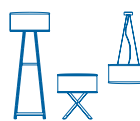
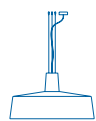
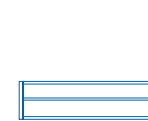
1 – 57
SUSPENSION
LAMPS
/ LÁMPARAS DE
SUSPENSIÓN2
Tam Tam8
Pleat Box16
Maranga22
Discocó34
Soho40
Nolita44
Nolita Cotton46
Mercer50
Compass54
S256
Olav58 – 73
CEILING
LAMPS
/ LÁMPARAS
DE TECHO60
Maranga62
Discocó64
Soho66
Plaff-on!70
Mercer72
Olav74 – 113
FLOOR LAMPS
/ LÁMPARAS
DE PIE76
Cala80
Funiculí88
Maranga94
Scantling100
Nolita102
Nolita Cotton104
Camp108
Ledpipe112
Cotton114 – 163
TABLE LAMPS
/ LÁMPARAS
DE SOBREMESA116
Polo122
Scantling126
Maranga130
Clea136
Nolita140
Nolita Cotton142
Mercer150
Atila154
Topolina158
Cotton162
Silo164 – 257
WALL LAMPS
/ LÁMPARAS
DE PARED166
Ledtube172
Ledtube R176
Ledcompass182
Ledpipe188
Scantling190
Tam Tam194
Scene200
Discocó204
Continua212
Nolita214
Nolita Cotton216
Mercer222
Atila224
Cotton226
204228
Zoo230
Big Mouse232
Silo236
Viga Mini238
Moma242
Manhattan T5246
Manhattan248
Beta252
Espejito, espejito...258 – 301
OUTDOOR
LAMPS
/ LÁMPARAS
DE EXTERIOR260
Cala268
Lab278
TXL290
Soho292
Duna296
Nagy302 – 349
ARCHITECTURAL
/ ARQUITEC-
TURAL304
Neón de Luz314
Atlas326
R.Axis332
SQ.Axis344
Lin

**COORDINATION
& CONTENT**
**/ COORDINACIÓN
Y CONTENIDO**

Isabel Valle, Javier Marset

**GRAPHIC DESIGN
& ART DIRECTION**
**/ DISEÑO GRÁFICO
Y DIRECCIÓN DE ARTE**

Folch Studio

**COVER
ILLUSTRATION**
**/ ILUSTRACIÓN
DE PORTADA**

Max Dalton

PHOTOGRAPHERS
/ FOTÓGRAFOS

Alexis Taulé, Coke Bartrina, Juan
Gregorio, LStudio, Miguel Fernández,
Miquel Ribot, Marc Hernández

PRINTING
/ IMPRESIÓN

Agpograf
Printed in Spain · *Impreso en España*
August 2012 · *Agosto 2012*

Marset thanks all the people
and entities that have lent us their
environment or their house to
illustrate this catalogue.

*Marset agradece a todas aquellas
personas y entidades que han cedido
su espacio y su casa para ilustrar
este catálogo.*

marset
BARCELONA

Marset stands for well-designed light. The fruit of a constant concern to explore the most subtle nuances while demonstrating the finest lighting effects. We create unmatched ambiances around the world, thanks to a collaboration of an international team of designers. We asked them for a snapshot of the light form that inspires them.

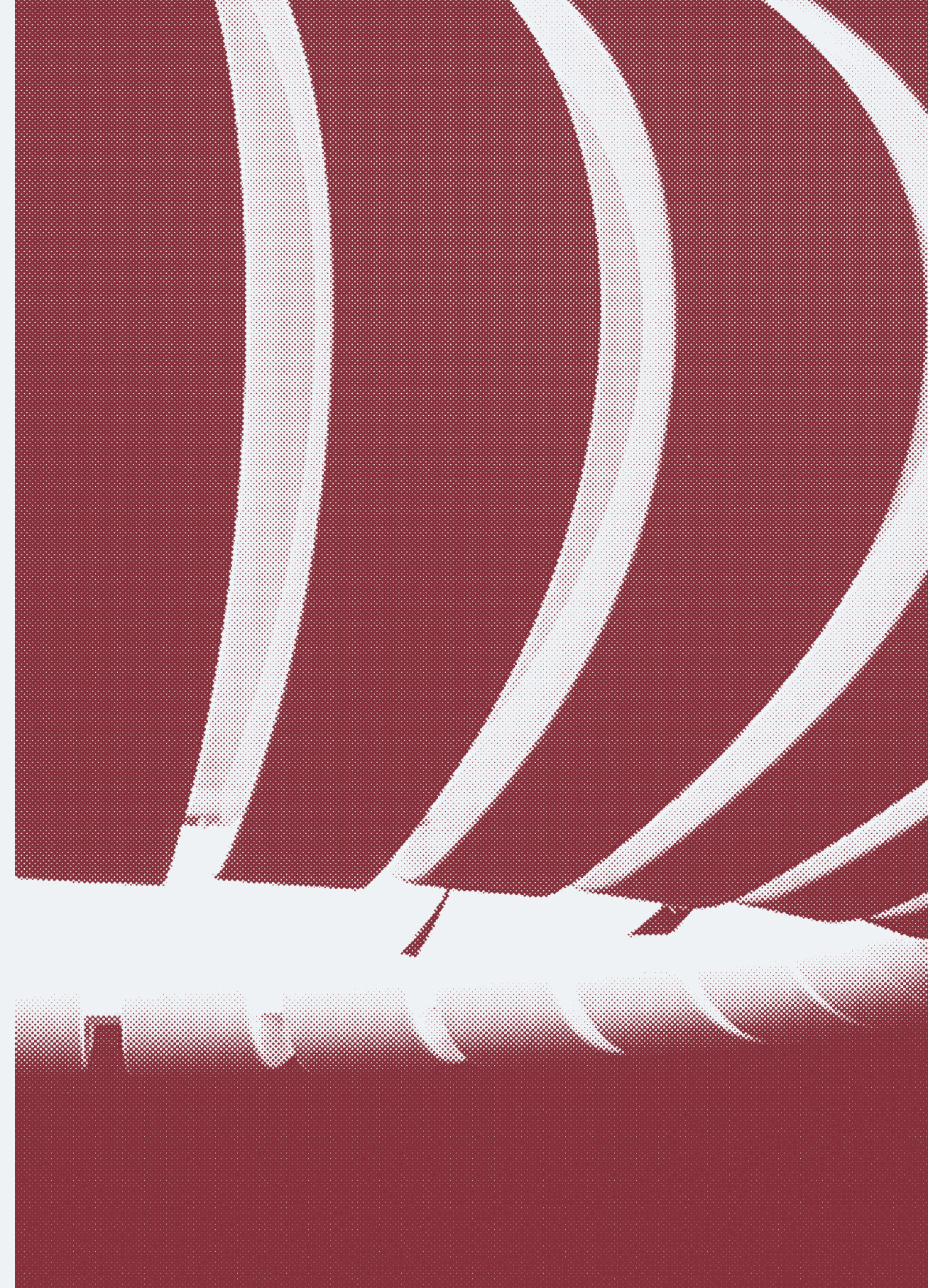

*Marset es luz con buen diseño.
El fruto de una constante inquietud
por explorar los matices y efectos
más finos de la iluminación.
Creamos ambientes singulares
por todo el mundo gracias a la
colaboración de un equipo
internacional de diseñadores; a ellos
les preguntamos por una imagen
de luz inspiradora.*



ANTONI MIRÓ

Sabadell, Spain, 1947

“The light at dawn, ideal for the nonce while I am meditating” · *“La luz del amanecer, idónea en mis momentos de meditación”*

**CHRISTOPHE MATHIEU**

Hamburg, Germany, 1961

“The reminiscent play of light and shade inside the Umbracle in Barcelona, a building intended to create shadowy niches; is the perfect place to take shelter from the heat and the sun” · *“El sugerente juego de luces y sombras del interior del Umbracle de Barcelona, un edificio destinado a crear espacios umbríos, perfecto para resguardarse del sol y del calor”*

**DANIEL LÓPEZ**

Santa Coloma de Gramanet, Spain, 1980

“Sunlight permeating a pool of spring water making its way through ferns and droplets of water. Amazing!” · *“Rayos de sol penetrando en el interior de un cenote, abriéndose paso entre helechos y saltos de agua. ¡Espectacular!”*

**FABIEN DUMAS**

Fort de France, Martinique, 1976

“The only light which floods the Polynesian island of my childhood – so rich, so abundant, so ubiquitous” · *“La luz única que inunda la isla polinesia de mi infancia. Tan rica, abundante y omnipresente”*



FRANCESC RIFÉ

Sant Sadurní d'Anoia, Spain, 1969

“The image of half light, be it natural or artificial. The dark side of the light always has a special allure for me” · *“Una imagen de penumbra, ya sea natural o artificial. El negativo de la luz siempre me resulta seductor”*



JAKOB TIMPE

Würzburg, Germany, 1967

“The sun as a sphere that emits light in beams of inconceivable power from a core, which one cannot observe directly. I like the simple analogy between a lamp and the sun. Hence, my model...an enigmatic light source that only allows you to see



its sparkling outline” · *“El sol como esfera que emite luz expulsando rayos con una potencia increíble y desde un centro imposible de mirar directamente. Me gusta la simple analogía entre una lámpara y el sol. De ahí mi maqueta... Una fuente de luz enigmática que solo te deja ver su contorno centelleante”*

JOAN GASPAR

Barcelona, Spain, 1966

“I find the beams from lighthouses inspiring; due to their symbolism, their functionality, and their architectural fusion. Lighthouses serve as reference points for sailors and are often found in spectacular surroundings,



which in many cases are inhospitable” · *“Encuentro inspiradora la luz de los faros. Por su simbolismo, funcionalidad y fusión con la arquitectura. Los faros sirven de señal a los navegantes y suelen estar situados en magníficos entornos, a menudo inhóspitos”*

LA GRANJA

Gabriele Schiavon, Padova, Italy, 1973

“The light from sparklers! Because it is alive, it mutates, and it changes without losing its essence until, slowly but surely, it goes out! And when it does, it leaves us wanting more – more laughter and more fun!” · *“¡La luz de las bengalas! Porque está viva, se transforma y cambia sin perder su*

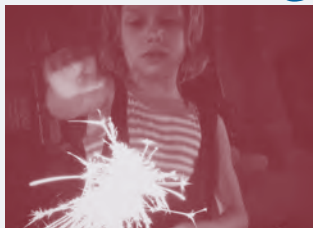

identidad hasta que, poco a poco, se apaga. Y cuando acaba siempre nos deja con ganas de más, ¡más sonrisas y más fiesta!”

LLUÍS PORQUERAS

Lleida, Spain, 1930

“The 60’s. Formentera. Sunset in Ses Salines. The smoke of plants from Afghanistan. As if by a miracle, the salt becomes a kaleidoscope of colour.



Atheist? Agnostic? No: pantheist! Light, the origin of life, is sacred” · *“Años 60. Formentera. Puesta de sol en Ses Salines. Humos afganos alternativos. Como un milagro las salinas se convierten en un caleidoscopio de colores. ¿Ateo?*

¿Agnóstico? No: panteísta. La luz, génesis de vida, es sagrada”

MASHALLAH DESIGN

Hande Akçayli, Istanbul, Turkey, 1974
Murat Koçyigit, Kiel, Germany, 1974

“We are inspired by the light as it tells a story in films” · *“Nos inspira la luz narrativa de las películas”*



MATHIAS HAHN

Osnabrueck, Germany, 1977

“My favorite light appears when the sun is low in the sky; in those few seconds when the colours and the contrasts are intensified.

What is light without a shadow?” · *“Mi luz favorita aparece cuando el sol está bajo, en esos momentos en que los colores y contrastes se intensifican. ¿Qué es la luz sin la sombra?”*



RUBÉN SALDAÑA

Salamanca, Spain, 1976

“The nocturnal glow of phosphorescence seas, known as milky seas. Each movement becomes an intense light trail that will fade very slowly. To go swimming as that happens could be a mystical experience...” · *“El resplandor nocturno de los mares fosforescentes, conocido como Mar de Ardora. Cada movimiento se convierte en una intensa estela luminosa que va desvaneciéndose muy lentamente. En esos momentos, darse un baño puede convertirse en una experiencia mística...”*



XAVIER MAÑOSA

Barcelona, Spain, 1981

“The light of the first hour of the evening in summer as it sneaks into our studio through the four skylights and the partly-covered hole in the ceiling. It creates five moving spotlights, which seem

to be searching for something amongst the unfinished bits and pieces there” · *“La luz de primera hora de la tarde que en verano se cuela por las cuatro claraboyas y el agujero medio tapado del techo de nuestro taller, creando cinco focos móviles que parecen buscar algo entre todas las piezas inacabadas de la sala”*



***SUSPENSION
LAMPS***

***LÁMPARAS
DE SUSPENSIÓN***

TAM TAM

Fabien Dumas, 2011



It's a juicy bunch of grapes, Nick Mason's drums from Pink Floyd, the constellation of Perseus...there are so many examples that could be used to describe the TAM TAM, a new perception in the world of lamps, which extols repetitiveness by focusing on the archetypal lampshade: a number of light sources pointed in different directions, geometrically arranged to invoke a feeling of organized chaos. The TAM TAM is suitable for any space. Using more than one, the sets of shades with their different positions and colours can be used to create vast, multi-coloured ceilings, each one different from any other. — *Es un jugoso racimo de uvas, los tambores de Nick Mason de Pink Floyd, la constelación de Perseo.... tantos ejemplos que podrían ilustrar la TAM TAM, un nuevo concepto de lámpara que exalta la repetición en la concentración del arquetipo de pantalla: varias fuentes de luz orientadas en distintas direcciones, geométricamente colocadas para evocar el caos. TAM TAM se adapta a cualquier espacio ya que el juego de pantallas y sus distintas posiciones y colores pueden combinarse y multiplicarse hasta crear un inmenso techo de luces, único cada vez.*



A central shade in lacquered aluminium, to which are attached various satellite shades that can be rotated through 360°. An opalescent methacrylate diffuser over the open end softens the light. — *Pantalla central de aluminio lacado, a la que se unen varias pantallas satélite que pueden orientarse 360° en cualquier posición. En su parte inferior, un difusor de metacrilato opal tamiza la luz.*

- Black · Negro (Ral 9011)
- White · Blanco (Ral 1013)
- Orange · Naranja (Ral 2000)
- Grey brown · Gris marrón (Ral 7013)
- Green · Verde (Ral 6025)
- Sand · Arena (Ral 7032)

Tam Tam 3

- ☛ 9x E27 FBT 18W
- 9x E27 HSGSA/C/V 42W

Tam Tam 5

- ☛ 13x E27 FBT 18W
- 13x E27 HSGSA/C/V 42W

Tam Tam Mini

- ☛ 5x E14 FBT 15W
- 5x E14 HSGSP/C/UB 42W

Tam Tam 1 ø50

- ☛ 3x E27 FBT 18W
- 3x E27 HSGSA/C/V 42W

Tam Tam 1 ø35

- ☛ 2x E14 FBT 15W
- 2x E14 HSGSP/C/UB 42W

Tam Tam³

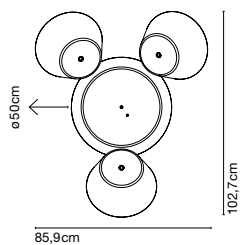
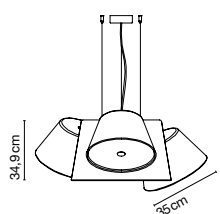

Tam Tam⁵

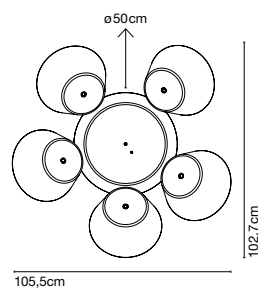
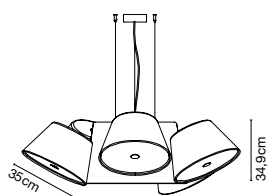

Tam Tam^{Mini}

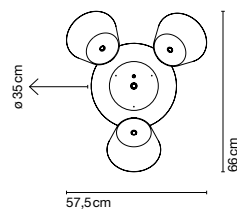
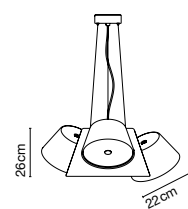

Tam Tam 1 ø50

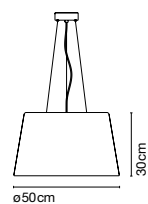

Tam Tam 1 ø35

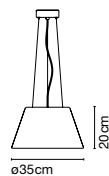

Range · Colección



Watch the video



In the TAM TAM³ and TAM TAM⁵, each shade can be personalised in any of the following colours: black, white, orange, brown, green or sand. — *En la TAM TAM³ y TAM TAM⁵, cada pantalla, se puede personalizar con el color que uno quiera, a escoger entre negro, blanco, naranja, marrón, verde y arena.*

In the TAM TAM MINI, the central shade is available in black or white, and the satellite shades can be combined in black, white, orange, brown, green or sand. — *En la TAM TAM MINI, la pantalla central está disponible en blanco o negro, y las pantallas satélites se pueden combinar en blanco, negro, naranja, verde o arena.*



Tam Tam Mini

PLEAT BOX

Xavier Mañosa & Mashallah, 2011



The idea behind the PLEAT BOX is that of a sophisticated combination between a digitally-designed crease in a piece of cloth, the silhouette of which is applied to a ceramic base.

The outer part of the lamp is offered in white ceramic, brown, black, terracotta and grey –the result of recycling different enamels. The brilliant white enamel interior creates a glitter effect, which enhances the light from the lamp. It can also be supplied in gold on the inside, which generates an extremely warm light.

PLEAT BOX has come about through the first-ever collaboration between Xavier Mañosa, a master ceramicist from Barcelona, and the Mashallah design studio in Berlin with Marset. — *El concepto de PLEAT BOX parte de un juego formal en el que tras diseñar digitalmente la caída del pliegue textil se aplica la silueta al material cerámico.*

El exterior de la lámpara se ofrece en cerámica blanca, marrón, negro, terracota y gris –resultado de reciclar diferentes esmaltes. El interior es de esmalte blanco brillante, que emite unos destellos que enriquecen la luz de la lámpara, o en oro generando una luz extremadamente cálida. PLEAT BOX es el resultado de la primera colaboración entre Xavier Mañosa (artesano ceramista de Barcelona) y Mashallah (estudio de diseño de Berlín) con Marset.



Ceramic diffuser with the inner part in brilliant white enamel or gold. Ceramic canopy. — Pantalla de cerámica con el interior de esmalte blanco u oro. Florón de cerámica.

○ White-white · Blanco-blanco

● White-gold · Blanco-oro

○ Grey-white · Gris-blanco

● Grey-gold · Gris-oro

● Terracotta-white · Terracota-blanco

● Terracotta-gold · Terracota-oro

● Black-white · Negro-blanco

● Black-gold · Negro-oro

● Brown-white · Marrón-blanco

● Brown-gold · Marrón-oro

Pleat Box 47

⇒ G9 48W ECO

⇒ G9 FBT 9W

○ E27 70W HSGSA/C/UB

⇒ E27 18W FBT Microtwist

Pleat Box 36

⇒ G9 48W ECO

⇒ G9 FBT 9W

○ E14 42W HSGSP/C/UB

⇒ E14 9W FBA

Pleat Box 24

⇒ G9 48W ECO

⇒ G9 FBT 9W

○ E27 53W HSGSA/C/UB

⇒ E27 18W FBT Microtwist

Pleat Box 13

⇒ G9 48W ECO

⇒ G9 FBT 9W

○ E27 53W HSGSA/C/UB

⇒ E27 18W FBT Microtwist

Pleat Box 47

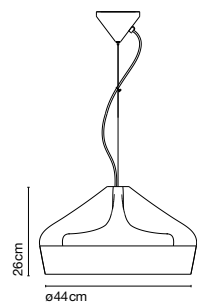

Pleat Box 36

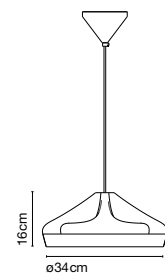

Pleat Box 24

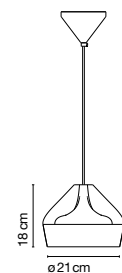

Pleat Box 13

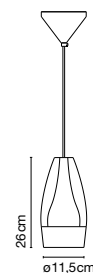

Watch the video



The PLEAT BOX is a sophisticated combination between a digitally-designed crease in a piece of cloth, the silhouette of which is applied to a ceramic base. — *PLEAT BOX parte de un juego formal en el que tras diseñar digitalmente la caída del pliegue textil se aplica la silueta al material cerámico.*





MARANGA

Christophe Mathieu, 2012



MARANGA is the name of a fruit, an imaginary fruit: exquisite, tempting, succulent. It reinterprets scandinavian style in the essentiality of its shape and its rational use of lighting to generate a warm, comfortable atmosphere.

The shade is made up of 32 slice-like pieces which fit together to allow chinks of light to escape. This interplay of light and dark generates an effect which is rich in shades of light and prevents glare, while an opening at the bottom fitted with a diffuser gives out direct light downwards. — *MARANGA es nombre de fruta, de fruta inventada: exquisita, incitante, succulenta. reinterpreta el estilo escandinavo en cuanto a la esencialidad de la forma y el uso racional de la iluminación para generar un ambiente cálido y confortable.*

La pantalla está formada por 32 piezas a modo de gajos que se intercalan entre sí dejando escapar resquicios de luz. Este juego de claroscuros genera un efecto rico en matices luminosos e impide el deslumbramiento, al tiempo que la abertura inferior provista de un difusor emite luz directa hacia abajo.



POEMA



A shade made up of 32 polycarbonate sections, all attached to an upper chromed metal cover. Underneath there is a transparent polycarbonate diffuser with a prismatic engraving. — *Pantalla compuesta de 32 piezas de policarbonato unidas entre sí a una tapa superior de metal cromado. En la parte inferior, un difusor de policarbonato transparente con grabado prismático.*

- White · Blanco
 - Sand · Arena (Ral 7032)
 - Umbra grey · Gris sombra (Ral 7022)
- Maranga 50**
 - 3x E27 70W HSGSA/C/UB
 - 3x E27 18W FBT
- Maranga 32**
 - 2x E14 HSGSP/C/UB 42W
 - 2x E14 FBT 15W

Maranga 50

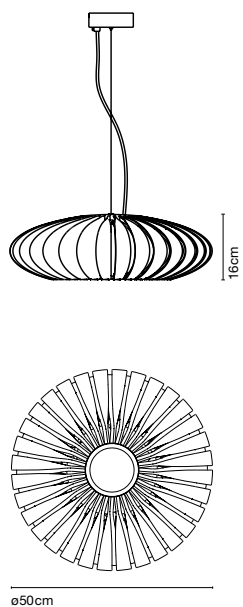

Maranga 32

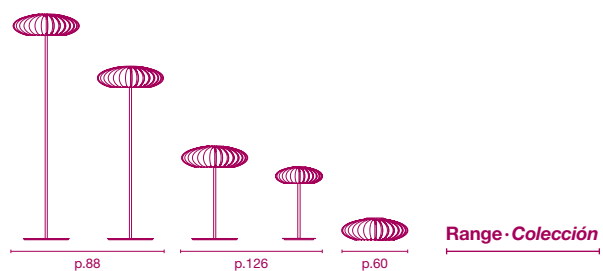
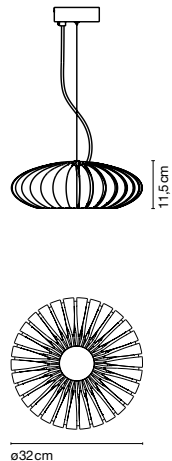

Watch the video





The MARANGA collection is available in two diameters -32cm and 50cm- and it comes in 3 colours: White, sand and umbra grey. — *La colección MARANGA se propone en dos diámetros -32cm y 50cm- y en tres colores: blanco, arena y gris sombra.*

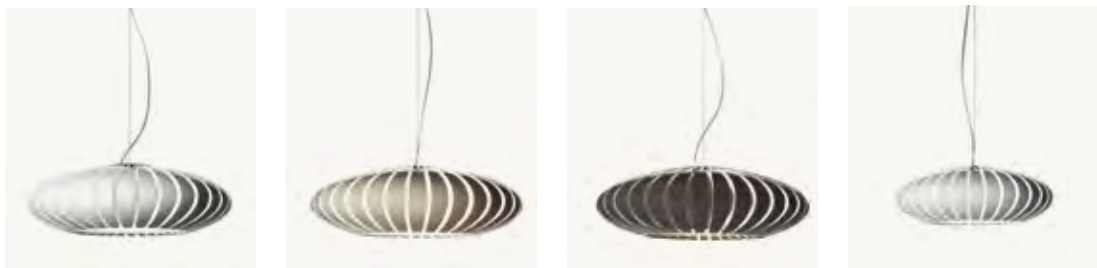

DISCOCÓ

Christophe Mathieu, 2008

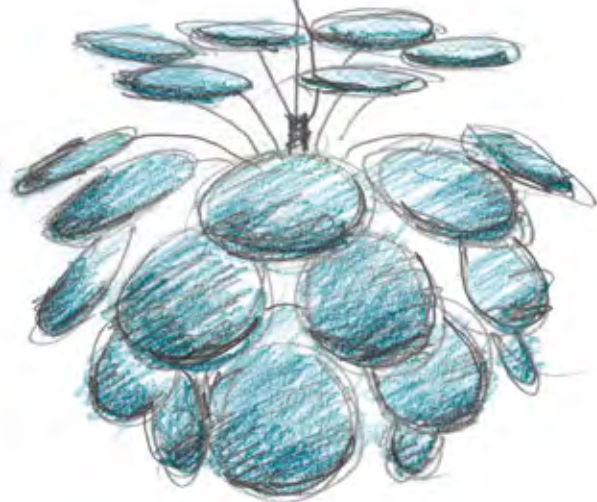



Exuberant and attractive, the DISCOCÓ range of fixtures offers an interplay of suggestive, highly effective lighting. The thirty-five ABS discs lacquered in white vibrantly reflect the internal light source. On the outside, this reflection varies depending on the angle of the light, at the same time that provides direct illumination from its underside. The chromed sphere to which the metal bars holding the discs are connected, provides a new interplay of glittering reflections. The DISCOCÓ family is available in white, turquoise blue, sand, chocolate, and a new colour: black-gold. — *Exuberante y atractiva, la familia de luminarias DISCOCÓ ofrece un juego de luces efectista y sugerente. Los 35 discos de abs lacado en blanco reflejan desde el interior la fuente de luz con viveza. En el exterior esa reflexión se ve matizada según la incidencia lumínica. Al mismo tiempo procura una iluminación directa descendente. La esfera cromada, donde se anclan las varillas metálicas que sujetan los discos, añade nuevos reflejos y destellos. Toda la serie DISCOCÓ está disponible en blanco, azul turquesa, arena, chocolate, y en un nuevo color: negro-oro.*







35 White opaque discs made in moulded abs. Chrome sphere. — 35 Discos de abs inyectado lacado. Esfera cromada.

- White · Blanco
- Sand · Arena (Ral 7032)
- Chocolate (Ral 8017)
- Turquoise · Turquesa (Ral 6034)
- Black-gold · Negro-oro

Discocó 132
 6x E27 FBA 23W (ø120)

Discocó 88
 3x E27 FBA 23W (ø120)
 3x E27 70W HSGSA/C/UV

Discocó 53
 E27 FBA 23W (ø120)
 E27 105W HSGSA/C/UV

Discocó 35
 E14 FBT 15W
 E14 42W HSGSP/C/UV

Discocó 132

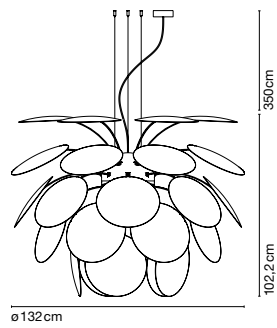

Discocó 88

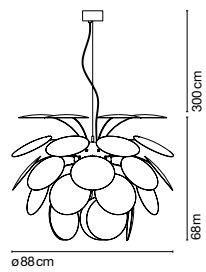

Discocó 53

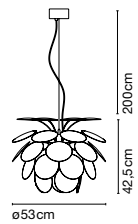

Discocó 35

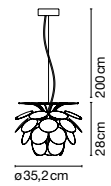

Watch the video

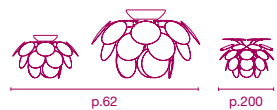

Range · Colección



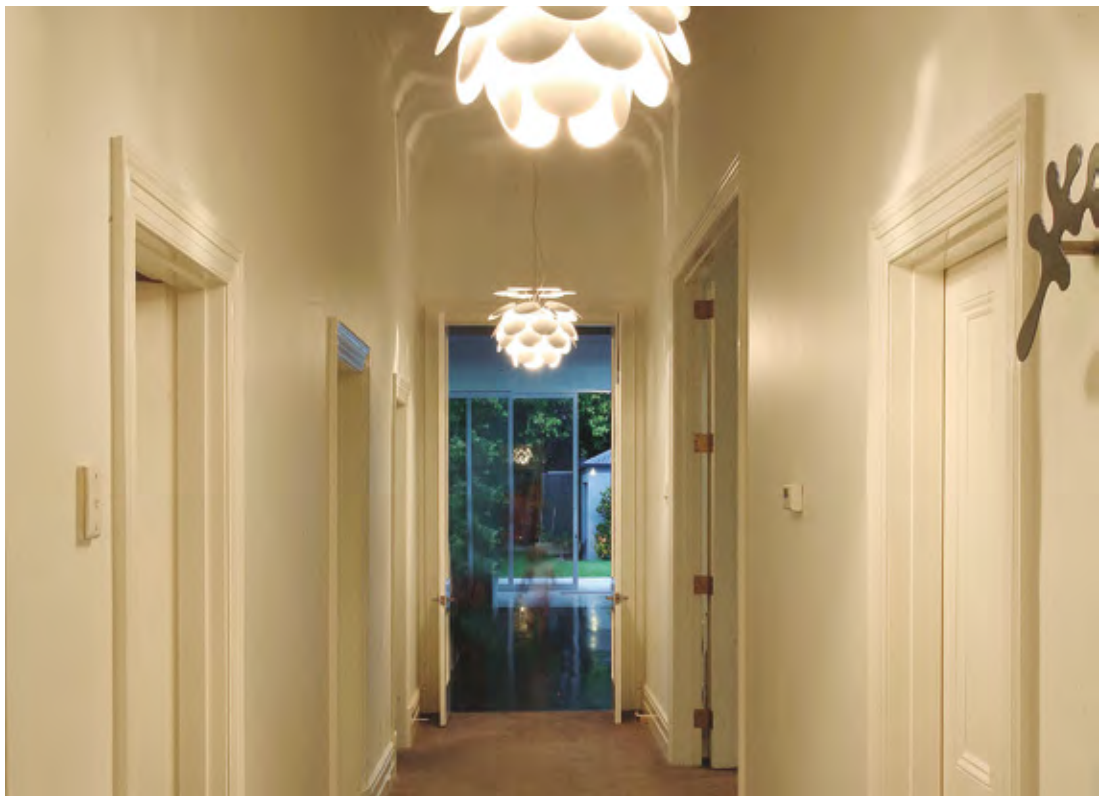

Available in a new colour:
Black-Gold. — *Disponibile
en un nuevo color: negro-oro.*









SOHO

Joan Gaspar, 2010



SOHO is presented as a statement, in recognition of the merits of the lamps traditionally used in markets, taverns and cafeterias. After studying different volumes, proportions and materials, new uses and lighting effects have emerged.

Through the use of rotary moulded polyethylene, large sizes can be obtained. With a diameter of 112 cm, it has been conceived for large spaces, while the 57cm model is ideal for lighting a dining table. A methacrylate diffuser produces an evenly distributed light. In the translucent white version, the whole structure emits ambient light.

— *SOHO se presenta como un alegato. Es un reconocimiento a los méritos de esa lámpara empleada tradicionalmente en mercados, tabernas y cafeterías. Tras reflexionar entorno a volúmenes, proporciones y materiales han surgido nuevos usos y efectos lumínicos. El empleo de polietileno rotomoldeado permite una pieza de gran tamaño. Con diámetro de 112cm se ha concebido para grandes espacios, mientras que la de 57cm ilumina perfectamente una mesa de comedor. Un difusor de metacrilato procura una luz homogéneamente tamizada. En la versión translúcida blanca, todo el cuerpo se convierte en emisor de luz ambiente.*



Shade in rotary moulded polyethylene. Methacrylate opal diffuser.
— Pantalla de polietileno rotomoldeado. Difusor de metacrilato opal

- White · Blanco (Ral 9003)
- Stone grey · Gris piedra (Ral 7039)
- Black · Negro (Ral 9005)

Soho 112

↔ 8x T5 24W

5x QR111 GU53 12V 35-50W
 + ○ 1x 22W+40W

5x CDM-R111 GX8,5 35W
 + ○ 1x 22W+40W

Soho 57

○ T5-C 22W+40W
 ○ T5-C 40W

Soho 112

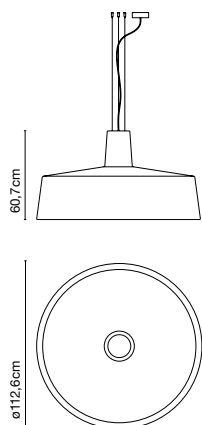

Soho 57

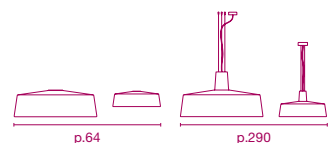
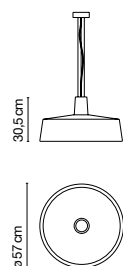

Range · Colección

dimmer

Soho 112 RGB LED
 Available · disponible



In the 112cm version, the adjustable spotlights provide direct lighting, in addition to the diffused light emitted by the screen. — En la versión de 112cm, los focos direccionables ofrecen una luz más directa, además de la luz difusa que emite la pantalla.



NOLITA

Joan Gaspar, 2008



Its aesthetic tone is the fundamental component of this collection. NOLITA is sophisticated and elegant because of the close attention paid to proportion. The simplicity of its design and structure contrasts with the materials used, particularly the injected polycarbonate for the shades with its different colours and textures. This feature breaks the classical silhouette slightly, but in no way compromises the elegance of the light.

The suspension version offers a wide variety of applications. Its simple shapes and shades that diffuse a warm and pleasant light, fit naturally in any environment. — *La estética es el elemento esencial en esta familia de lámparas. La colección NOLITA es sofisticada y elegante gracias a un trabajo exhaustivo en sus proporciones. Su sencillez formal y constructiva contrasta con los materiales utilizados, principalmente el polycarbonato inyectado de las pantallas, y con sus diferentes colores y texturas. La silueta clásica se trastoca así levemente, pero sin ceder en elegancia.*

La versión de suspensión permite un uso flexible de esta lámpara ya que puede encajar con naturalidad en cualquier entorno, por su simplicidad en las formas y su difusor que proporciona una luz cálida y agradable.



Conic diffuser with a double shade made of engraved polycarbonate. – Difusor cónico de doble pantalla de policarbonato con grabado.

- Black · Negro
- White · Blanco
- Transparent · Transparente

Nolita 39
 ○ E27 70W HSGSA/C/UB
 ○ E27 FBT 18W

Nolita 25
 ○ E14 42W HSGSP/C/UB
 ○ E14 FBA 9W

Nolita 39

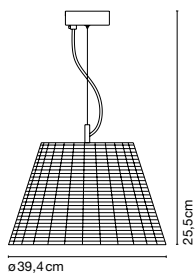

Nolita 25

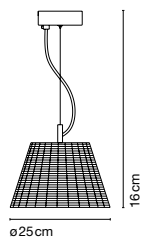

Range · Colección



NOLITA COTTON

Joan Gaspar, 2009



The NOLITA COTTON has a double-screen diffuser made of polycarbonate on the inside and natural cotton ribbons on the outside. Its ribbed construction filters a richly varied light. — *La versión NOLITA COTTON dispone de un difusor de doble pantalla con policarbonato en su interior y cintas de algodón crudo en el exterior. Su estructura encintada tamiza una luz rica en matices.*

Conic diffuser with a double shade made of polycarbonate on the inside part and raw cotton ribbons on the outside. — *Difusor cónico de doble pantalla: policarbonato en su interior y cintas de algodón en el exterior.*

● Natural · Crudo

Nolita Cotton 39

○ E27 70W HSGSA/C/UB

⊖ E27 FBT 18W

Nolita Cotton 25

○ E14 42W HSGSP/C/UB

⊖ E14 FBA 9W

Nolita Cotton 39

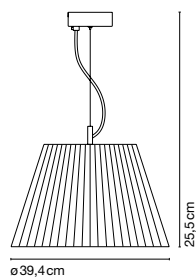

Nolita Cotton 25

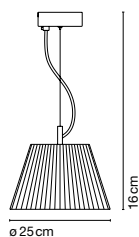

Range · Colección

p.102 p.140 p.214



MERCER

Joan Gaspar & Javier M. Borrás, 2005

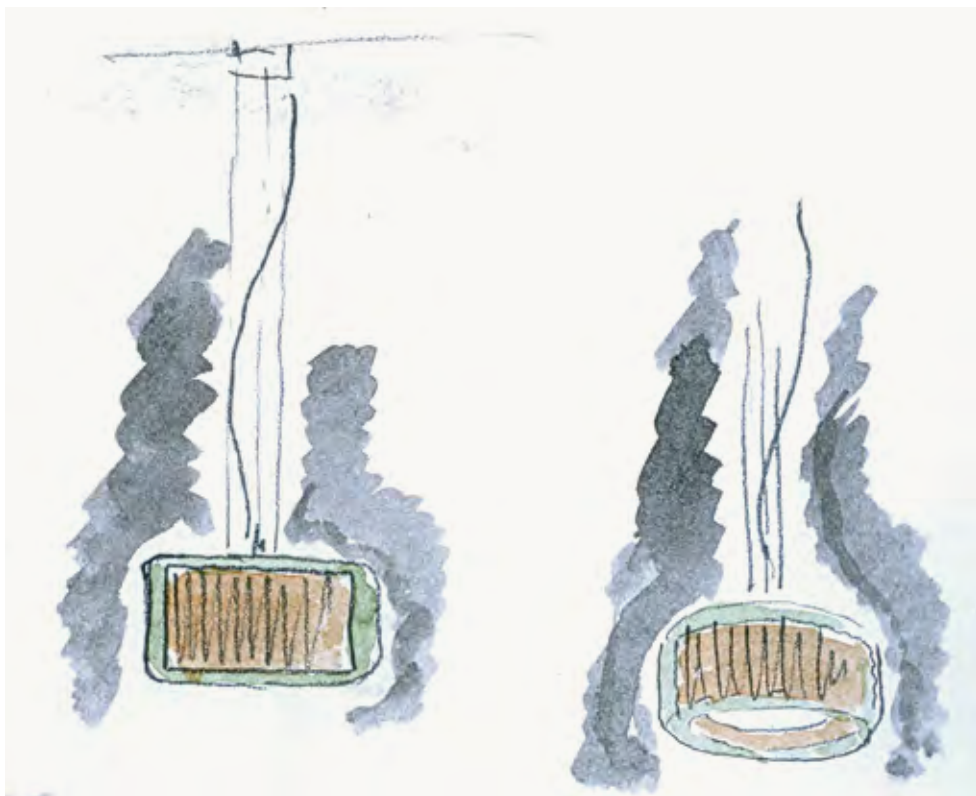

MERCER is a beautiful and elegant lamp. The fusion of different materials achieves a spectacular result due to its pure cotton ribbed shade floating in a transparent blown glass structure. The inner diffuser is available in natural or black cotton ribbons and, in a new modern and minimalistic version, in pearl white. — *MERCER es una lámpara bella y elegante. En ella la fusión de materiales de distinta naturaleza consigue un producto de gran espectacularidad ya que que su pantalla de cinta de algodón flota en una estructura de cristal soplado transparente. El difusor interior está disponible en cintas de algodón crudo o negro y, en una nueva versión moderna y minimalista, en blanco perla.*



Cotton shade that floats inside a transparent blown glass structure. Opal diffuser disc on the lower part. — *Pantalla de algodón que flota en una estructura de cristal soplado transparente. Disco difusor opal en la parte inferior.*

- Black · Negro
- Natural · Crudo
- Pearl White · Blanco perla

Mercer 44
 ○ 2x E27 70W HSGSA/C/UB
 ○ 2x 18W E27 FBT

Mercer 20
 ○ E14 42W HSGSP/C/UB
 ○ E14 FBA 9W

Mercer 30
 ○ E27 70W HSGSA/C/UB
 ○ 15W E27 FBT

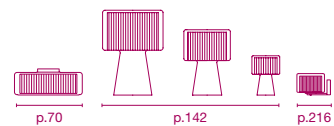
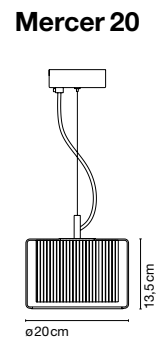
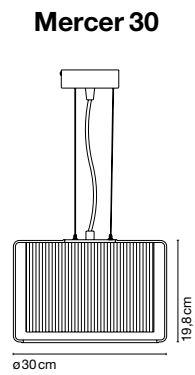
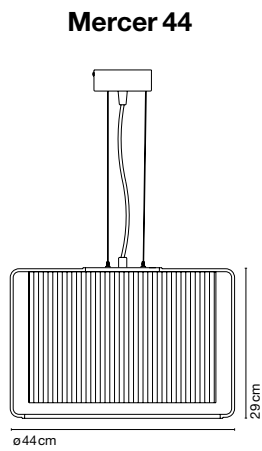

Range · Colección



COMPASS

Christophe Mathieu, 1997

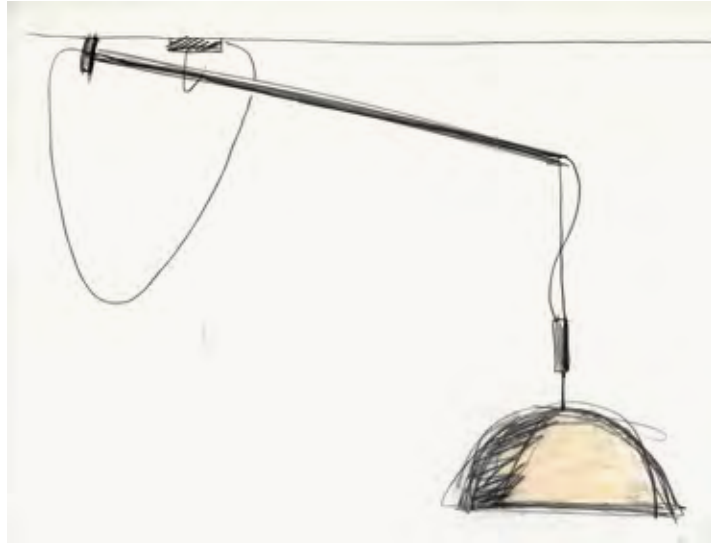

Sometimes it is necessary to adapt light to specific and changing needs. The COMPASS has achieved this. The solution was to shift the light from the center to the periphery. A regulating system has been incorporated as well as a silicone wheel which allows concentric movements of the lamp structure, ideal for extendable lamps. The chromed metallic structure is available in two different shades: a semi-sphere in white methacrylate or a natural cotton ribboned shade. A basic manual version is also available. — *A veces es necesario adaptar la luz a necesidades momentáneas. COMPASS lo consigue. La solución consiste en incorporar un sistema para regular la altura de la pantalla así como una rueda de silicona que permite movimientos concéntricos, como si fuera un compás, abarcando 360° y con un diámetro máximo de dos metros. Se puede escoger entre una semiesfera de metacrilato blanco o una pantalla de cinta de algodón crudo. También existe en versión básica, una estructura mínima para un sube y baja manual.*



Chromed matte steel structure with a silicone wheel that work like a pair of compasses. Shades: white methacrylate semi-sphere or natural cotton ribbon cylindrical shade. — Estructura de metal cromada mate con rueda giratoria a modo de compás. Pantallas: semiesfera de metacrilato blanco o pantalla cilíndrica de cintas de algodón crudo.

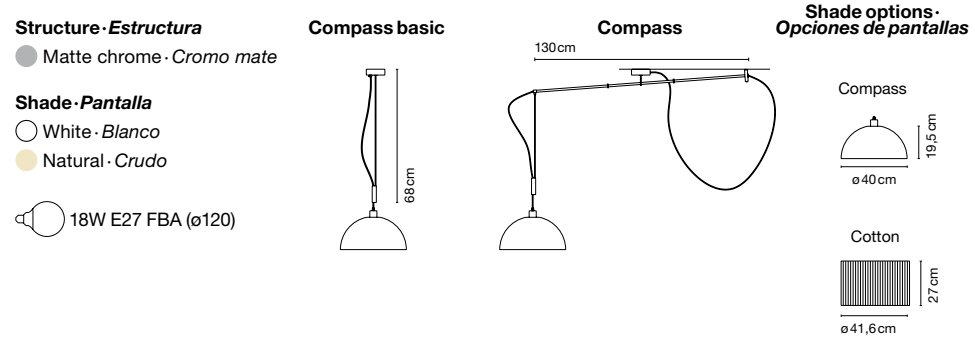

Range of positions - Variedad de posiciones
Adjustable height - Ajustable en altura

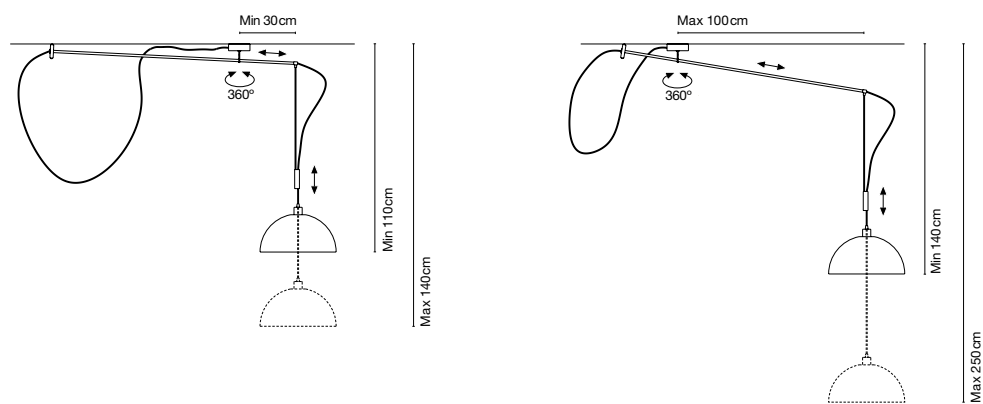

360° Rotation - Rotación de 360°





S2

Joan Gaspar, 2003

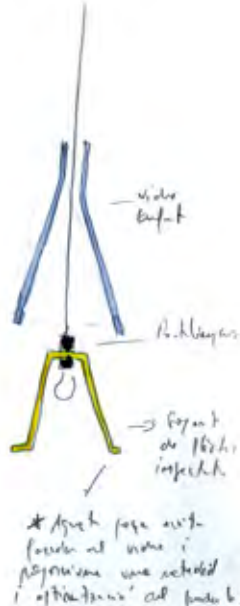

This pendant lamp in opal glass is based on a simple, clean shape to light up both domestic surroundings as well as more open area. A clasp system facilitates the height adjustment of the light. — *Esta lámpara de suspensión de cristal opal es, en su concepción, una forma sencilla y limpia de iluminar tanto un entorno doméstico como otros espacios. Un sistema de pinza permite jugar con la altura de la luminaria.*

Translucent polycarbonate structure. Opal blown glass shade. A clip adapts the length of the wire. — Cuerpo interior de policarbonato transparente que soporta un difusor de cristal soplado opal. Pinza para adaptar la longitud del cable eléctrico.

○ White - Blanco

○ E27 53W HSGSA/C/UB

○ E27 FBT 18W

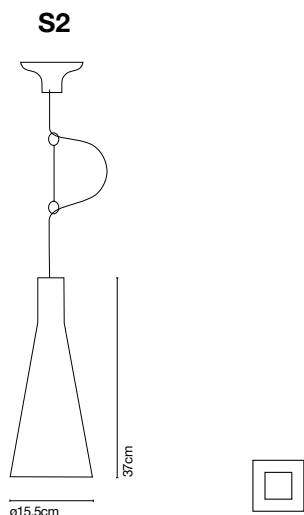

OLAV

Cristian Díez, 1999

OLAV is a simple and geometric lamp that brings to mind a Scandinavian design in which the reflection of light occurs through the top section. Through the cylindrical shape of the opal blown glass, the light generated is direct as well as diffused: an excellent treatment of light. This is why both versions, suspended and ceiling, achieve the goal of illuminating with a soft light. — *OLAV es una lámpara sencilla y de formas geométricas, inspirada en el diseño nórdico en el que la reflexión de la luz se realiza a través de su parte superior. Gracias al cristal opal soplado en forma de cilindro que la conforma, la luz que genera es tanto directa como difusa, lo que confiere un excelente tratamiento de la luz. Es por ello que tanto su versión de suspensión como de techo consiguen transmitir una luz suave, sin estridencias.*

Opal blown glass shade over a translucent polycarbonate structure. On the upper part, silver grey metallic diffuser. — Pantalla de cristal soplado opal sobre estructura de policarbonato transparente. En la parte superior, difusor metálico pintado de gris plata.

● Silver grey-white · Gris plata-
blanco

○ E27 70W HSGSA/C/UV

○ E27 FBT 18W

Olav

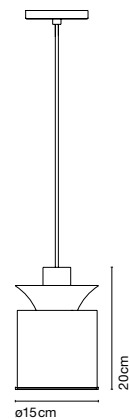

Range · Colección

p.72



**CEILING
LAMPS**

**LÁMPARAS
DE TECHO**

MARANGA

Christophe Mathieu, 2012

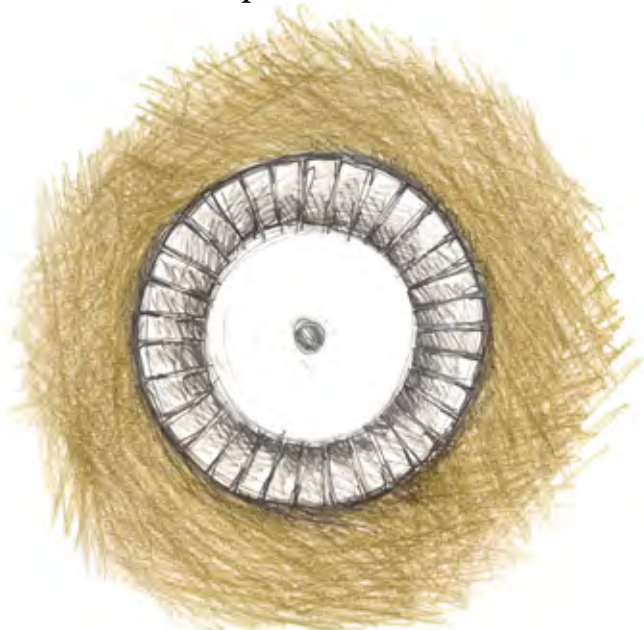

MARANGA is the name of a fruit, an imaginary fruit: exquisite, tempting, succulent. It reinterprets Scandinavian style in the essentiality of its shape and its rational use of lighting to generate a warm, comfortable atmosphere.

The shade is made up of 32 slice-like pieces which fit together to allow chinks of light to escape. This interplay of light and dark generates an effect which is rich in shades of light and prevents glare, while an opening at the bottom fitted with a diffuser gives out direct light downwards. — *MARANGA es nombre de fruta, de fruta inventada: exquisita, incitante, succulenta. Reinterpreta el estilo escandinavo en cuanto a la esencialidad de la forma y el uso racional de la iluminación para generar un ambiente cálido y confortable.*

La pantalla está formada por 32 piezas a modo de gajos que se intercalan entre sí dejando escapar resquicios de luz. Este juego de claroscuros genera un efecto rico en matices luminosos e impide el deslumbramiento, al tiempo que la abertura inferior provista de un difusor emite luz directa hacia abajo.

Watch the video



A shade made up of 32 polycarbonate sections, all attached. Underneath there is a transparent polycarbonate diffuser with a prismatic engraving. — Pantalla compuesta de 32 piezas de policarbonato unidas entre sí. En la parte inferior, un difusor de policarbonato transparente con grabado prismático.

- White · Blanco
- Umbra grey · Gris sombra (Ral 7022)
- Sand · Arena (Ral 7032)
- 3x E27 70W HSGSA/C/UB
- 3x E27 18W FBT

Maranga C



16cm

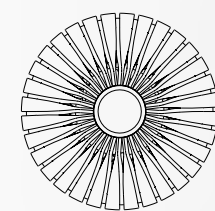

ø50cm

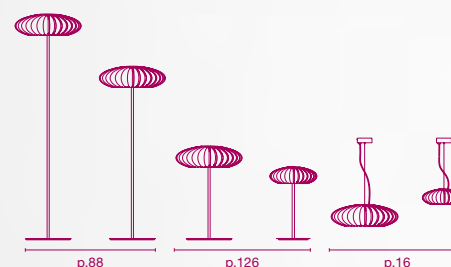

p.88 p.126 p.16

Range · Colección



DISCOCÓ

Christophe Mathieu, 2009



This lamp consists in a series of lacquered discs that float around a chromed semi-sphere. These discs act as layers that shield the light source, at the same time redirecting and reflecting the light onto the underlying discs. All of this combined results in a distinct and unique light which fills and enriches space. — *Esta lámpara consiste en una serie de discos lacados que flotan alrededor de una semiesfera cromada. Estos discos actúan como capas que protegen la fuente de luz, al tiempo que redirigen y reflejan el haz de luz hacia los discos inferiores. El resultado es una lámpara única y sorprendente que llena el espacio de múltiples matices.*



Opaque discs made in moulded ABS. Chromed semi-sphere. — *Discos opacos de ABS inyectado. Semiesfera cromada.*

- White · Blanco
- Turquoise · Turquesa (Ral 6034)
- Chocolate (Ral 8017)
- Sand · Arena (Ral 7032)
- Black-gold · Negro-oro

Discocó C88
 ○ 3x E27 23W FBA (ø120)
 ○ 3x E27 70W HSGSA/C/UB

Discocó C53
 ○ E27 23W FBA (ø120)
 ○ E27 105W HSGSA/C/UB

Discocó C88



Discocó C53

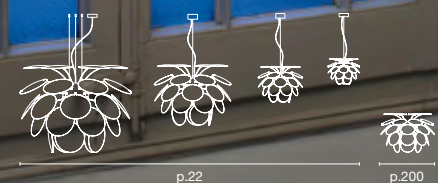

Range · Colección

Watch the video



SOHO

Joan Gaspar, 2010

SOHO is presented as a statement, in recognition of the merits of the lamps traditionally used in markets, taverns and cafeterias. After studying different volumes, proportions and materials, new uses and lighting effects have emerged. Through the use of rotary moulded polyethylene, large sizes can be obtained. With a diameter of 112 cm, it has been conceived for large spaces, while the 57cm model is ideal for lighting passageways and corridors. In the translucent white version, the whole structure emits ambient light. — *SOHO se presenta como un alegato. Es un reconocimiento a los méritos de esa lámpara empleada tradicionalmente en mercados, tabernas y cafeterías. Tras reflexionar entorno a volúmenes, proporciones y materiales han surgido nuevos usos y efectos lumínicos. El empleo de polietileno rotomoldeado permite una pieza de gran tamaño. Con diámetro de 112cm se ha concebido para grandes espacios, mientras que la de 57cm ilumina perfectamente espacios de paso. En la versión translúcida blanca, todo el cuerpo se convierte en emisor de luz ambiente.*

Shade in rotary moulded polyethylene. Methacrylate opal diffuser
— **Pantalla de polietileno rotomoldeado. Difusor de metacrilato opal.**

- White · Blanco (Ral 9003)
- Stone grey · Gris piedra (Ral 7039)
- Black · Negro (Ral 9005)

Soho C112

8x T5 24W

5x QR111 GU53 12V 35-50W
+ 1x 22W+40W

5x CDM-R111 GX8,5 35W
+ 1x 22W+40W

Soho C57

T5-C 22W+40W

Soho C 112

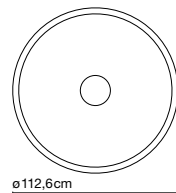

Soho C 57



dimmer

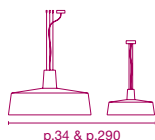

p.34 & p.290

Range · Colección



PLAFF-ON!

Joan Gaspar, 2010

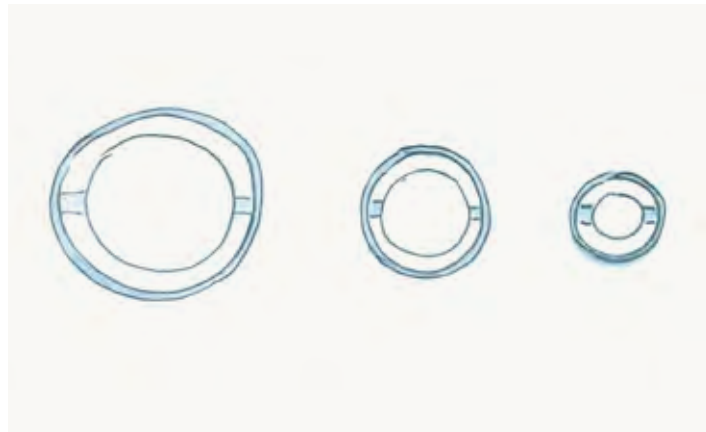

The informal tone of its name perfectly matches the intention to offer an alternative to this type of lighting fixture. A ceiling lamp whose beauty lies in its simplicity and clarity, at the same time as offering multiple lighting effects thanks to its design. The structure around the white blown glass diffuser is set slightly apart from the ceiling and filters the light upwards, creating a glowing halo. This same aluminium ring, which is also white on the inside, acts as a reflector and creates a new halo that surrounds the shade with direct light. Available in three diameters, it can also be used as a wall fixture. — *El tono de desenfado del nombre es un reclamo que subraya su intención de ofrecer una alternativa a este tipo de luminaria. Es un plafón que busca su atractivo en la simplicidad y nitidez, pero también en el efecto de luz múltiple, alcanzado gracias a su diseño. La estructura que orbita alrededor del difusor, de vidrio soplado blanco, queda ligeramente despegada del techo y filtra la luz hacia arriba generando un halo luminoso. Ese mismo aro de aluminio, también blanco en su interior, actúa como reflector y crea un nuevo halo que circunda la pantalla con luz directa. Disponible en tres diámetros, puede utilizarse además como aplique de pared.*



Ring made of lacquered aluminium which supports an opal blown glass shade. — *Aro de aluminio lacado que soporta un cristal soplado opal.*

Structure · Estructura

- Black · Negro
- Silver grey · Gris plata

Diffuser · Difusor

- White · Blanco

Plaff-on! 50 dimmer

- 4x 42W HSGSA/C/UB
- 4x E27 FBT 20W
- T5-C 22W + T5-C 40W

Plaff-on! 33

- 2x E27 FBT 18W
- 2x 42W HSGSA/C/UB
- R7s 120W ECO 114mm
- 2x G24 q-3 TC-DEL 26W

Plaff-on! 20

- 2x G9 48W ECO
- 2x G9 FBT 9W
- R7s 80W ECO 75mm

Plaff-on! 50

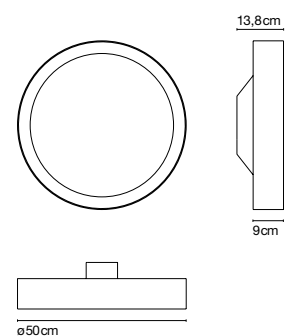

Plaff-on! 33

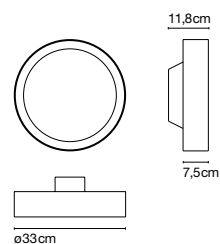

Plaff-on! 20

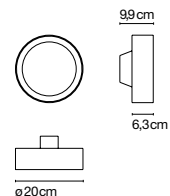

MERCER

Javier M. Borrás & Joan Gaspar, 2010

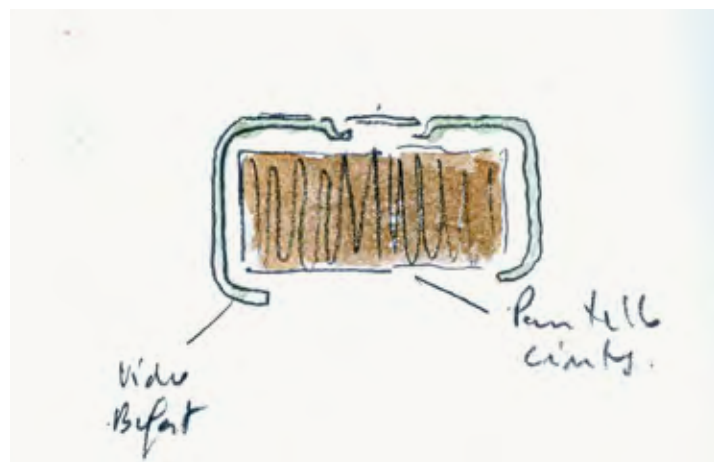

The ceiling version of the MERCER lamp joins this family of lighting fixtures that stand out for their subtle reversal of roles: the cloth shade is inside a structure of transparent blown glass. The glass delicately protects the shade in natural/black pleated cotton or in a sophisticated pearl white fabric, at the same time as producing additional reflections. The main aim of this lamp is to give the ceiling of a room a delicate, warm glow, at the same time as providing illumination.

— *La versión de techo de la lámpara MERCER se une a esta familia de luminarias que destaca por una sutil inversión de papeles: la pantalla de tela queda en el interior de una estructura de cristal soplado transparente. El cristal protege con delicadeza un plisado de algodón crudo/negro o un sofisticado tejido en blanco perla, a la vez que genera reflejos adicionales. El objetivo principal de este aplique es vestir el techo de una estancia con un traje ligero y cálido mientras ilumina.*



Cotton shade that floats inside a transparent blown glass structure. — *Pantalla de algodón que flota en una estructura de cristal soplado transparente.*

- Black · Negro
- Natural · Crudo
- Pearl White · Blanco perla

2x E27 FBT 18W
2x E27 42W HSGSA/C/UB

Mercer C



Range Colección

OLAV

Cristian Díez, 1999

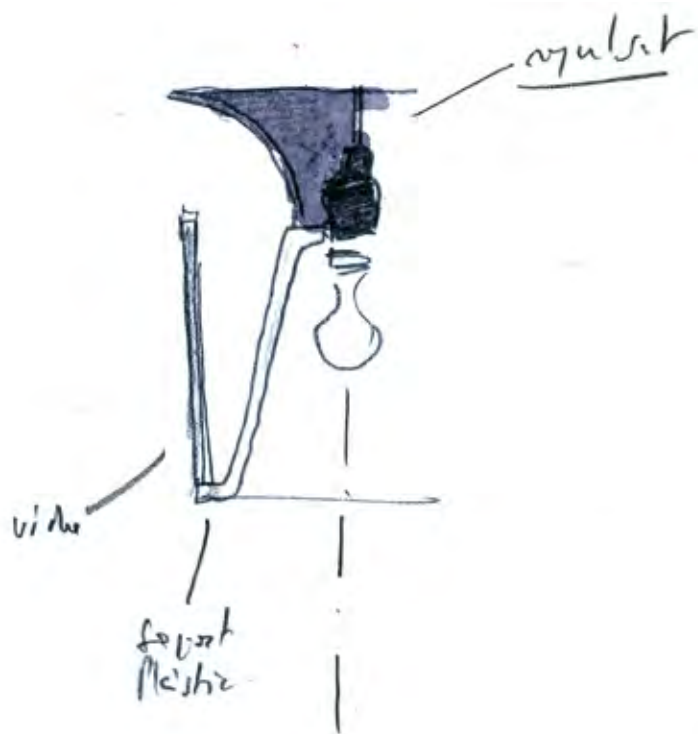

The ceiling mounted OLAV, as well as the pendant version, is a lamp that brings to mind a Scandinavian design in which the reflection of light occurs through the top. The cylindrical shape of the opal blown glass generates both a direct and a diffused light. OLAV is above all functional but it does not neglect the basic premises of any good design: an excellent treatment of light. — OLAV de techo, al igual que la versión de suspensión, se inspira en el diseño nórdico en el que la reflexión de la luz se realiza a través de su parte superior. Funcional y geométrica, está formada por un cristal opal soplado en forma de cilindro que genera una luz tanto directa como difusa. OLAV es ante todo funcional pero sin descuidar las premisas básicas de cualquier buen diseño: un excelente tratamiento de la luz.



Opal blown glass shade over a translucent polycarbonate structure. On the upper part, silver grey metallic diffuser. — Pantalla de cristal soplado opal sobre estructura de policarbonato transparente. En la parte superior, difusor metálico pintado de gris plata.

● Silver grey-white · Gris plata-blanco

○ E27 70W HSGSA/C/UB

⊞ E27 FBT 18W

Olav P



p.038

Range Colección



**FLOOR
LAMPS**

**LÁMPARAS
DE PIE**

CALA

Joan Gaspar, 2012



Everybody likes a warm, comfortable light. This is exactly what the new CALA lamp achieves by means of the combination of its light but resistant structure in oak wood, inspired by the classic artist's easel, and its pearl-white polyester shade.

It is available in three sizes - 140cm, 165cm and 180cm. Next to a sofa or an armchair is the ideal place for the smallest version, whereas the other two models have been conceived as general lighting in more open spaces. The CALA collection is also available in an outdoor version. — *A todos nos gusta una luz cálida y confortable. Esto es precisamente lo que consigue la nueva lámpara CALA, diseñada combinando una estructura ligera y resistente en madera de roble, inspirada en los clásicos caballetes de pintor, con una pantalla de poliéster en blanco perla. Disponible en tres tamaños, -140, 165 y 180cm-, la versión menor es idónea para su colocación al lado de un sofá o butaca y las dos mayores han sido concebidas como iluminación general para espacios más amplios. La familia CALA también está disponible en versión de exterior.*



Varnished oak structure. White polyester shade, made of a PVC-PET laminated film. Methacrylate difuser. — Estructura de roble barnizado. Pantalla de poliéster blanco formada por dos láminas de PVC y PET. Difusor de metacrilato.

Structure · Estructura

● Oak · Roble

Shade · Pantalla

● Pearl white · Blanco perla

Cala P180

○ 3x E27 70W HSGSA/C/UB

⊞ 3x E27 FBT 18W

Cala P165

○ 3x E27 70W HSGSA/C/UB

⊞ 3x E27 FBT 18W

Cala P140

○ 3x E27 70W HSGSA/C/UB

⊞ 3x E27 FBT 18W

Cala P180

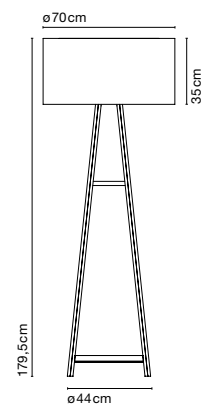

Cala P165

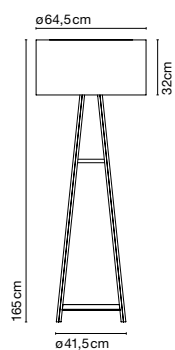

Cala P140

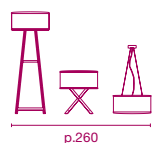
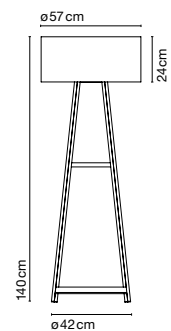

Range · Colección



FUNICULÍ

Lluís Porqueras, 1979 / 2012



FUNICULÍ is a new edition of a lamp designed in 1979. Lluís Porqueras has always sought an absolute simplicity in his designs, doing away with everything superfluous to leave the essence of the useful, simple object. The name FUNICULÍ comes from the concept of a “funicular” action - moving up and down. The mechanism for raising and lowering the lamp uses a pair of clips which make it very easy to adapt the height of the shade to the needs of the user. The shade itself can be rotated through 360° to point the beam of light wherever it is required.

The base of FUNICULÍ is covered in rubber on the bottom, avoiding the cold contact between the metal and the floor and adding stability to the lamp. — FUNICULÍ es una reedición de una lámpara diseñada en 1979.

Lluís Porqueras siempre ha diseñado buscando una simplicidad absoluta, eliminar lo superfluo hasta dejar la esencia del objeto útil y sencillo.

El nombre de FUNICULÍ viene del concepto de acción funicular, de subir y bajar. Este sencillo mecanismo de sube y baja se consigue mediante una doble pinza que permite cambiar la altura de la pantalla para adaptarse a las necesidades del usuario. La pantalla ofrece una rotación de 360° para dirigir el haz de luz hacia donde convenga.

La base de la FUNICULÍ tiene una goma que recubre el contorno, evita el contacto frío del metal con el suelo y añade estabilidad a la lámpara.

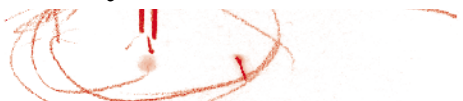

Base and stem in lacquered iron. Shade made of lacquered aluminium. Black rubber which wraps the outline base up.
— Base y fuste en hierro lacado. Pantalla en aluminio lacado.
Caucho negro que envuelve el contorno de la base.

- Moss grey · *Gris musgo* (Ral 7022)
- White · *Blanco* (Ral 9001)
- Black · *Negro* (Ral 9005)
- Red · *Rojo* (Ral 3024)
- Beige (Ral 1000)

- E27 53W HSGSA/C/UB
- E27 FBT 18W

Funiculí

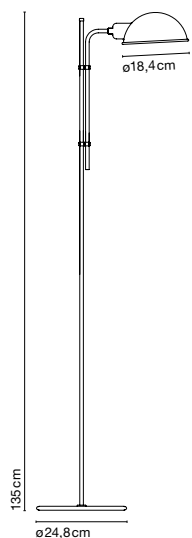

Watch the video





The Story Behind

La historia de la Funiculí



In the late 70's, I had a lamp firm, Vapor. The things it made were very simple: Although the industrial process included 25 operations, the end result was one of absolute simplicity; what interested me was pruning, pruning and pruning again to leave nothing but the essence of a useful, simple object.

Over time, I realised that I was a very bad businessman. Fortunately, Marset took an interest in what we were doing at Vapor and much of our catalogue became part of their collection. Moreover, my former colleague Joan Gaspar, a good friend of mine, became the creative manager at Marset. Now, 30 years later, Marset has decided to re-release Funiculí.

We have all had the ubiquitous desk light with a flexible arm. It was a rounded object, with a very simple shade covering the typical Edison light bulb. It occurred to me to free this shade and give it more features and mobility. I added a curved stem and clips to allow it to be raised and lowered. Hence the name funiculí, from the "funicular" action of going up and down, like the funicular railways of Tibidabo or Montjuïc in Barcelona.

I have always believed that the light in a room must also go with shadow, that there should be contrasts with the points of light. This is what creates well-being, calm; your home must be a refuge from the aggressive outdoors in the city. Lights are lit for several hours a day, and the rest of the time they must maintain a certain discretion so that they do not bother you when they are off, and only become noticeable when they are on... like glow worms. Fashion does not interest me, and I have never made fashionable lights because they soon go out of fashion. I have always made lamps I liked.

A finales de los años 70, tenía una empresa de lámparas, Vapor. Las cosas que hacía eran muy simples: aunque el proceso industrial incluyera 25 operaciones, el resultado final tenía que ser de una simplicidad absoluta; lo que me interesaba

era sacar, sacar y sacar hasta dejar nada más que la esencia del objeto útil y sencillo.

Con el tiempo, me he dado cuenta de que era muy mal empresario. Afortunadamente, Marset se interesó en lo que estaba haciendo en Vapor y gran parte de nuestro catálogo pasó a formar parte de su colección. Además, mi antiguo colaborador y buen amigo Joan Gaspar se convirtió en el director creativo de Marset. Ahora, 30 años después, Marset ha decidido reeditar la Funiculí.

Todos hemos tenido esa lámpara de escritorio con el brazo flexible. Era un objeto redondo, con una pantalla muy simple que cubría la típica bombilla de Edison. Se me ocurrió liberar esa pantalla y darle más cualidades y movilidad. Añadí una tija curvada con unas pinzas que permitían subir o bajar la pantalla. De ahí el nombre de Funiculí, de la acción "funicular" de subir y bajar, como el funicular del Tibidabo o de Montjuïc en Barcelona.

Siempre he pensado que la luz en un espacio interior debe tener también sombras, que tiene que haber contrastes entre los puntos de luz. Eso es lo que crea el bienestar y la calma; tu casa como refugio de la agresividad exterior de la ciudad. Las lámparas se encienden unas horas al día, el resto del tiempo deben mantener una cierta discreción para no molestar cuando están apagadas, y sólo volverse presentes cuando se encienden... como las luciérnagas. La moda no me interesa, nunca he hecho lámparas de moda porque enseguida pasan de moda. Siempre he hecho lámparas que me gustan.



MARANGA

Christophe Mathieu, 2012



MARANGA is the name of a fruit, an imaginary fruit: exquisite, tempting, succulent. It reinterprets Scandinavian style in the essentiality of its shape and its rational use of lighting to generate a warm, comfortable atmosphere.

The shade is made up of 32 slice-like pieces which fit together to allow chinks of light to escape. This interplay of light and dark generates an effect which is rich in shades of light and prevents glare, while an opening at the bottom fitted with a diffuser gives out direct light downwards. — *MARANGA es nombre de fruta, de fruta inventada: exquisita, incitante, succulenta. Reinterpreta el estilo escandinavo en cuanto a la esencialidad de la forma y el uso racional de la iluminación para generar un ambiente cálido y confortable.*

La pantalla está formada por 32 piezas a modo de gajos que se intercalan entre sí dejando escapar resquicios de luz. Este juego de claroscuros genera un efecto rico en matices luminosos e impide el deslumbramiento, al tiempo que la abertura inferior provista de un difusor emite luz directa hacia abajo.



A shade made up of 32 polycarbonate sections, all attached to an upper chromed metal cover. Underneath there is a transparent polycarbonate diffuser with a prismatic engraving. The base and the stem are in lacquered metal. — *Pantalla compuesta de 32 piezas de policarbonato unidas entre sí a una tapa superior de metal cromado. En la parte inferior, un difusor de policarbonato transparente con grabado prismático. Base y tija de metal lacado.*

- White · Blanco
- Umbra grey · Gris sombra (Ral 7022)
- Sand · Arena (Ral 7032)
- 3x E27 70W HSGSA/C/UB
- 3x E27 18W FBT

Maranga P170

Maranga P130

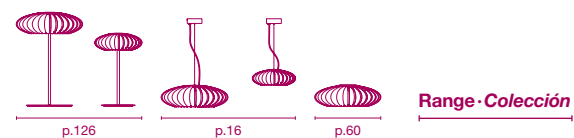
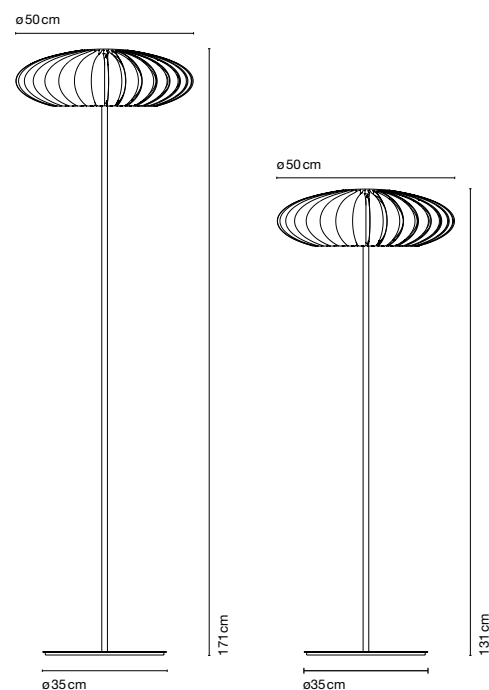

Watch the video





SCANTLING

Mathias Hahn, 2010



A combination of basic geometric shapes and the use of wood together with metal give this family of lamps a homely appearance as well as a clearly defined personality.

All of the movements of the fully rotating shade use arms and hinges, and its technical precision means that springs or counterweights are not necessary in order to maintain the selected position. SCANTLING is a term used to define the size to which a piece of wood or stone is measured and cut, derived from the name of an old unit of measurement. The interplay of the different elements used in its design gives this lamp an archetypal, almost graphic appearance. — *El ensamblaje de formas geométricas básicas y el uso de madera junto al metal, otorgan a esta familia de luminarias un aire próximo y a la vez una marcada personalidad. Todos los movimientos de la pantalla, con rotación completa, quedan resueltos mediante rótulas y brazos, y su precisión técnica hace que no requiera muelles ni contrapesos vistos para mantener la posición escogida. La palabra inglesa SCANTLING hace referencia a las dimensiones de la sección de una varilla de madera, y deriva de una herramienta de medida utilizada antiguamente. La evidencia de su juego constructivo procura a esta lámpara una cierta imagen arquetípica, casi gráfica.*



Lacquered iron stem and base. Solid oak arm supports a lacquered aluminium shade. The switch is built into the diffuser — *Tija y base de hierro lacado. Brazo de roble macizo sostiene un difusor de aluminio. El interruptor está incorporado en la pantalla.*

Structure – Estructura

- Stone grey-oak · Gris piedra-roble
- White-oak · Blanco-roble

Shade – Pantalla

- Stone grey · Gris piedra
- White · Blanco

⦿ E27 FBT 18W

⦿ E27 PAR20 50W

Scantling P73

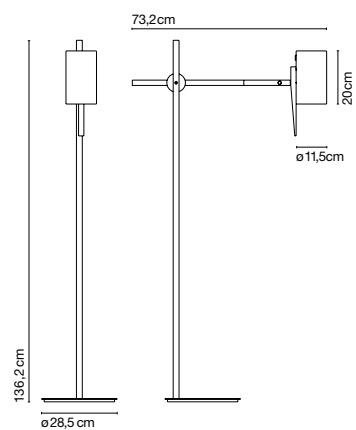

Scantling P40

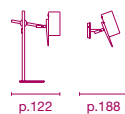
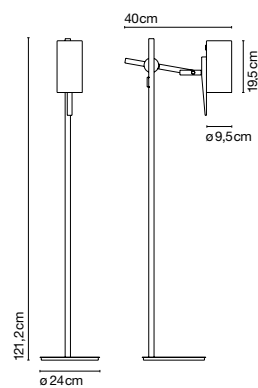

Range · Colección

p.122 p.188

Watch the video





NOLITA

Joan Gaspar, 2008

Close attention to the overall proportions is crucial in the sophistication and elegance of the NOLITA collection. The simplicity of its design contrasts with the materials used, particularly the moulded polycarbonate for the shades with its different colours and textures. The shade tilts allowing different positioning of the light beam. This feature breaks the basic lamp's silhouette slightly but in no way compromises the elegance of the light. — *La colección NOLITA es sofisticada y elegante gracias a un trabajo exhaustivo en sus proporciones. Su sencillez formal contrasta con los materiales utilizados, principalmente el policarbonato inyectado de las pantallas, con sus diferentes colores y texturas. Es remarcable el brazo móvil que permite orientar la pantalla y el haz de luz, trastocando levemente la silueta de la lámpara, pero sin ceder en elegancia.*

Conic diffuser with a double shade made of engraved polycarbonate. Anodized aluminium base and stem.
— *Difusor cónico de doble pantalla de policarbonato con grabado. Fuste y base en aluminio anodizado.*

Structure - Estructura

- Black · Negro
- Aluminium · Aluminio

Shade - Pantalla

- Black · Negro
- White · Blanco
- Transparent · Transparente

- E27 70W HSGSA/C/UB
- E27 FBT DIM 18W

Nolita P

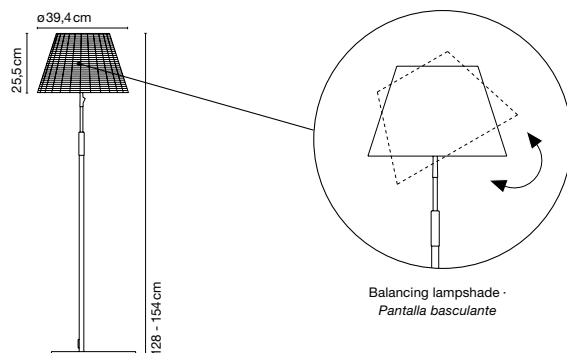

Range · Colección



NOLITA COTTON

Joan Gaspar, 2009

This version has a double-screen diffuser made of polycarbonate on the inside and natural cotton ribbons at the outside, which creates a cosy light atmosphere. It incorporates a touch dimmer system. — *La versión NOLITA COTTON dispone de un difusor de doble pantalla con policarbonato en su interior y cintas de algodón crudo en el exterior creando así una comfortable atmósfera de luz. Incorpora un sistema dimmer al tacto.*

Conic diffuser with a double shade made of polycarbonate on the internal part and raw cotton ribbons on the outside. Anodized aluminium base and stem. — *Difusor cónico de doble pantalla: policarbonato en su interior y cintas de algodón en el exterior. Fuste y base en aluminio anodizado.*

Structure · Estructura

- Black · Negro
- Aluminium · Aluminio

Shade · Pantalla

- Natural · Crudo

○ E27 70W HSGSA/C/UB

○ E27 FBT DIM 18W

Nolita Cotton P

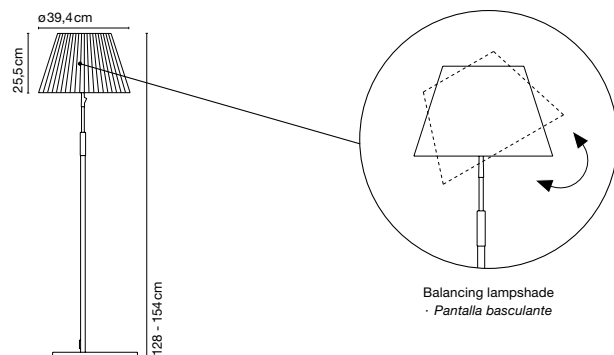

Dimmer



p.44

p.140

p.214

Range · Colección

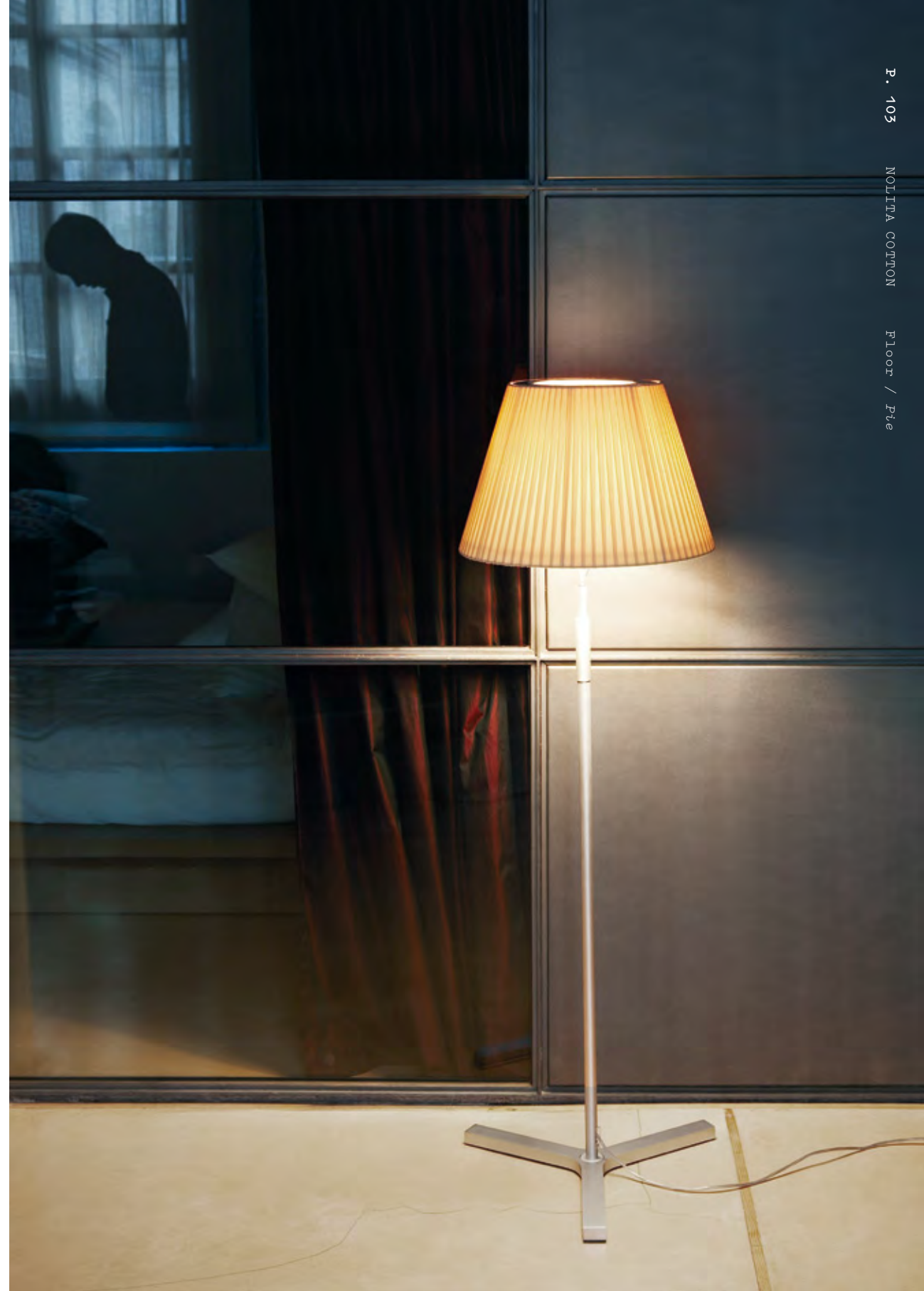

CAMP

Jakob Timpe, 2004

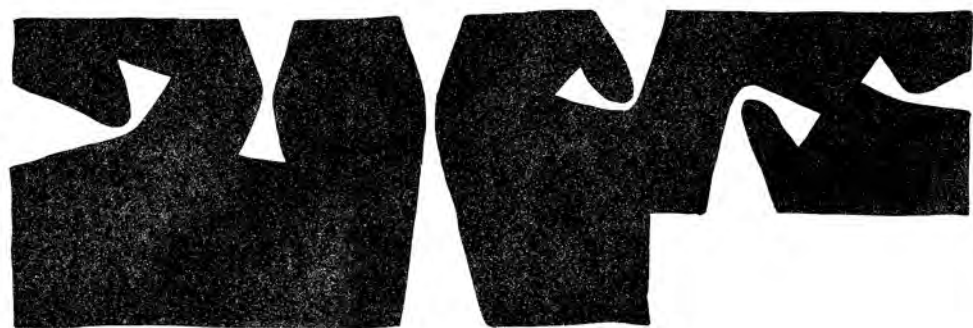

With a Pop and Avant-Garde look, the CAMP lamp is capable of adapting to any lighting needs and position, as it can be focused anywhere direct light is needed. A large cone fused together with a smaller one through a flexible neck. Thanks to its multiple positions, CAMP can also create a pleasant atmosphere of indirect light when focused towards the ceiling. — *Con una estética pop y vanguardista, la lámpara CAMP es capaz de adaptarse a cualquier necesidad lumínica y posición, ya que se orienta hacia cualquier lugar donde sea necesaria una iluminación directa. Un cono grande y otro más pequeño se unen mediante un cuello flexible.*

Dentro de sus múltiples posiciones CAMP es también un objeto capaz de crear un ambiente acogedor de luz indirecta cuando se dirige al techo.



The flexibility of its neck reproduces the movement of the straws used to drink sodas — *La flexibilidad de su cuello reproduce el movimiento de las cañitas utilizadas para sorber refrescos.*



A large polypropylene structure, in black or white, composed by two cones and a flexible neck built with 15 discs. Aluminium reflector. — Gran estructura de polipropileno, blanco o negro, compuesto de dos conos y un cuello flexible de 15 discos. Reflector de aluminio.

- Black · Negro
- White · Blanco

- ⦿ E27 70W HSGSA/C/UB
- ⦿ 18W E27 FBT DIM

Camp

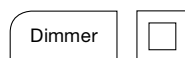
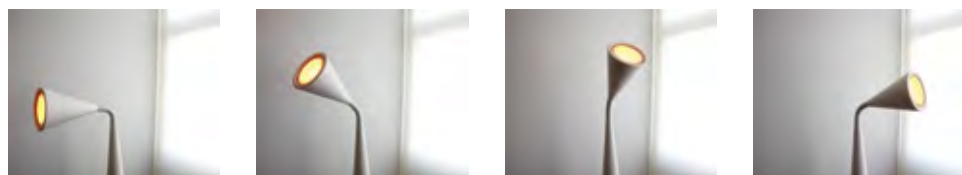
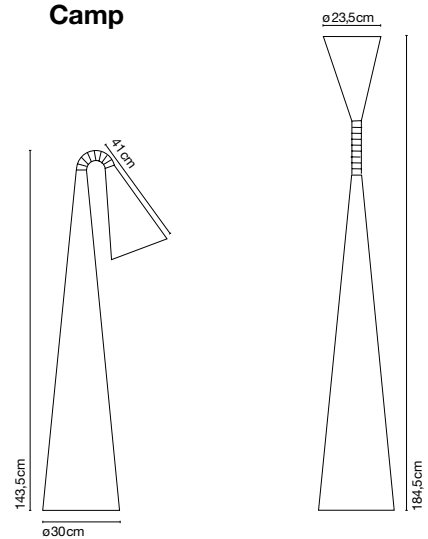

LEDPIPE

Joan Gaspar, 2008



Its calculated dimensions and its rotating system makes the LED-PIPE a highly functional reading light. This new version consists of a lens that directs a clear beam of light produced by a 3 watt LED light source. This high efficiency lighting, together with the low temperature LED, allows totally secure and effective use swing to the integrated switch in the diffuser. — *Tanto sus estudiadas dimensiones como el sistema de rótula la hace extremadamente funcional para la lectura. Utiliza como fuente de luz un LED de 3W dotado de una lente que dirige con absoluta nitidez el haz de luz. Esta buena eficiencia lumínica unido a la baja temperatura del LED permite la interacción con total seguridad y funcionalidad ya que, además, el interruptor está integrado en el difusor.*



Structure and base of painted metal. Injected aluminium diffuser with stainless steel lid. Built-in switch. — Estructura y base de metal pintado. Difusor en inyección de aluminio con tapa de acero inoxidable. Interruptor incorporado en el difusor.

- Black · Negro
- White · Blanco
- Silver grey · Gris plata

3W LED 700mA 95lm
(included / incluida)

Ledpipe P

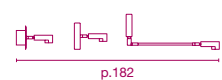
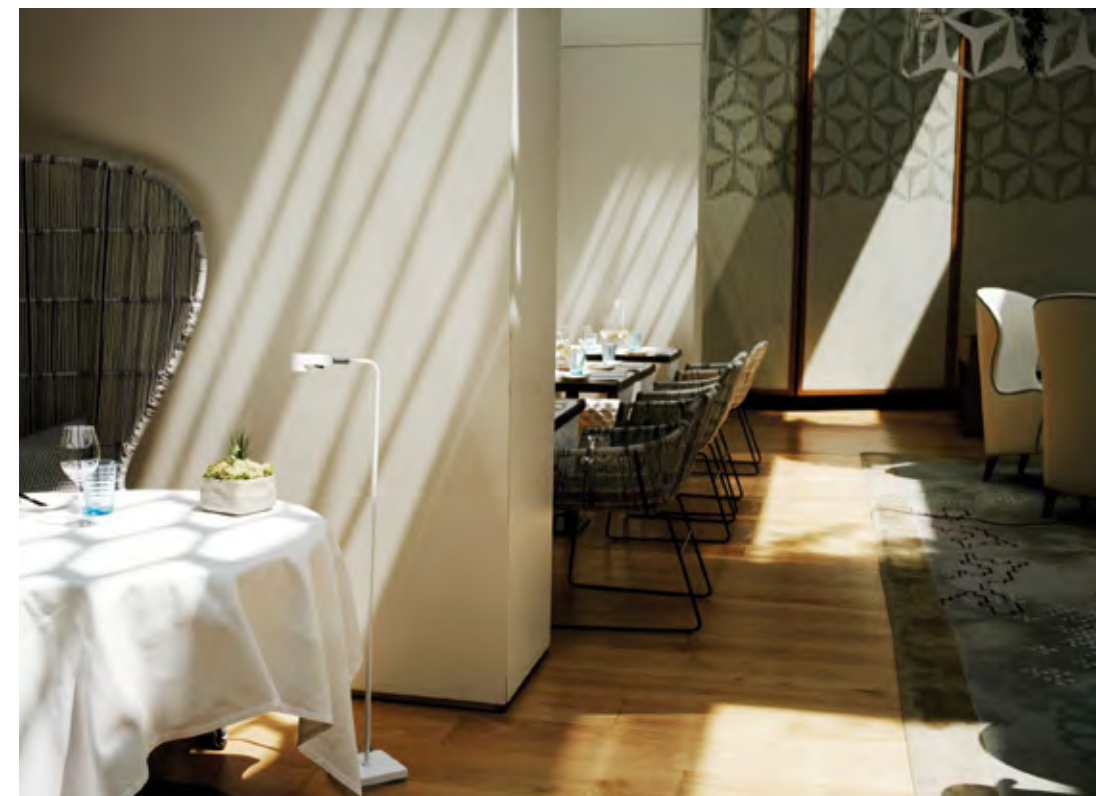
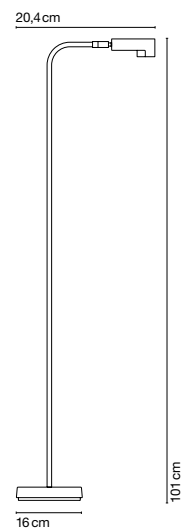

Range · Colección



COTTON

Javier M. Borrás, 1998

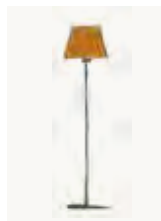

The COTTON family has hints of a classic lamp air with a contemporary design. The high quality of the ribboned shade exudes a rich light with many textures and blends. — *La familia COTTON destila un aire de lámpara clásica con un diseño contemporáneo. La gran calidad de su pantalla encintada de algodón crudo proporciona una luz rica en matices y relieves.*

Base and stem in matte chromed metal. Raw cotton ribboned shade. — Fuste y base en metal cromado mate. Pantalla de cintas de algodón crudo.

Structure · Estructura

● Matte chrome · Cromo mate

Shade · Pantalla

● Natural · Crudo

○ E27 70W HSGSA/C/UB

□ 18W E27 FBT

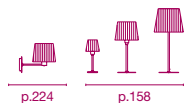
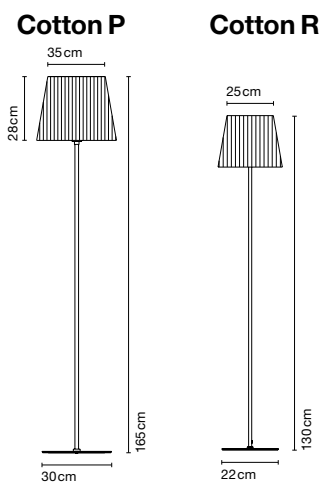

Range · Colección



***TABLE
LAMPS***

***LÁMPARAS
DE SOBREMESA***

POLO

Joan Gaspar, 2012



The fluidity of its movements and its total stability make this flexible fitting a light source which can be moved around the table while taking up hardly any space. This articulated lamp features LED technology, enabling the light to be directed accurately without burning yourself if you touch the shade.

Its fully movable structure is made of injection-moulded aluminium with joint and arm built into a single piece. The switch with its wheel system is located on the top of the head. — *La fluidez de sus movimientos y su perfecta estabilidad hacen de este flexo un punto de luz que se puede mover alrededor de la mesa sin apenas ocupar espacio. Esta lámpara articulada incorpora tecnología LED, lo que permite dirigir el haz de luz con precisión tocando la pantalla sin quemarse.*

Su estructura totalmente orientable está realizada en inyección de aluminio integrando rótula y brazo en una misma pieza. El interruptor con sistema de rueda se encuentra en la parte superior del cabezal.



Body and diffuser in lacquered aluminium. A switch is incorporated into the diffuser. — *Estructura y difusor de aluminio lacado. Interruptor incorporado al difusor.*

- Black · Negro
- White · Blanco

8W LED 500lm (included · incluido)

Polo

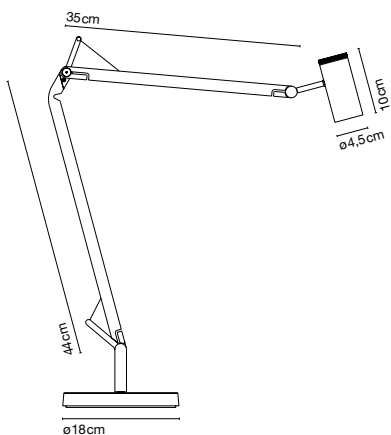

Base

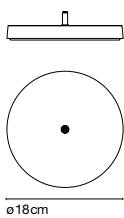

**Table bracket
Soporte mesa**

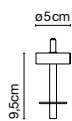

**Wall bracket
Soporte pared**

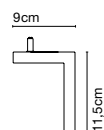

**Clamp
Mordaza**

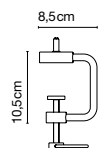

Watch the video

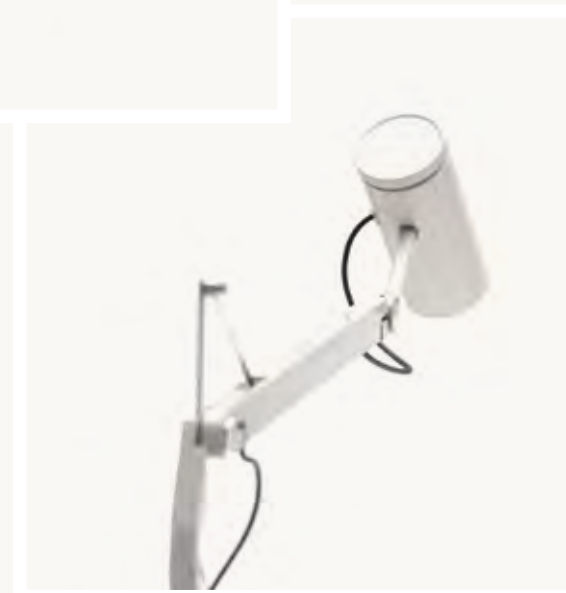
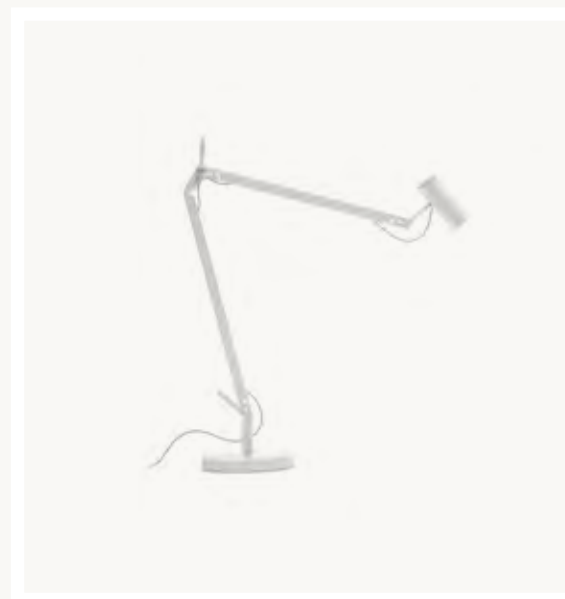



SCANTLING

Mathias Hahn, 2010

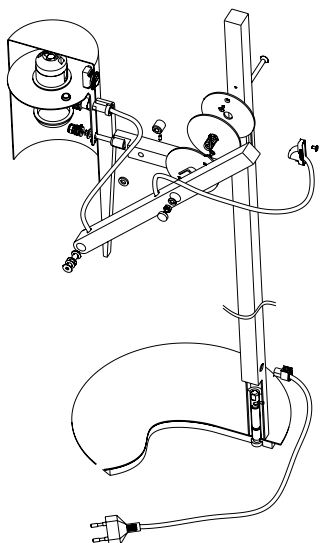

A combination of basic geometric shapes and the use of wood together with metal give this family of lamps a homely appearance as well as a clearly defined personality.

All of the movements of the fully rotating shade use arms and hinges, and its technical precision means that springs or counterweights are not necessary in order to maintain the selected position. The interplay of the different elements used in its design gives this lamp an archetypal, almost graphic appearance. — *El ensamblaje de formas geométricas básicas y el uso de madera junto al metal, otorgan a esta familia de luminarias un aire próximo y a la vez una marcada personalidad. Todos los movimientos de la pantalla, con rotación completa, quedan resueltos mediante rótulas y brazos, y su precisión técnica hace que no requiera muelles ni contrapesos vistos para mantener la posición escogida. La evidencia de su juego constructivo procura a esta lámpara una cierta imagen arquetípica, casi gráfica.*



Lacquered iron stem and base. Solid oak arm supports a lacquered aluminium shade. The switch is built into the diffuser.
 — *Tija y base de hierro lacado. Brazo de roble macizo sostiene un difusor de aluminio. El interruptor está incorporado a la pantalla.*

Structure - Estructura

- Stone grey-oak · Gris piedra-roble
- White-oak · Blanco-roble

Shade - Pantalla

- Stone grey · Gris piedra
- White · Blanco

- ⦿ E27 FBT 18W
- ⦿ E27 PAR20 50W

Scantling S

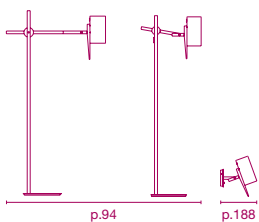
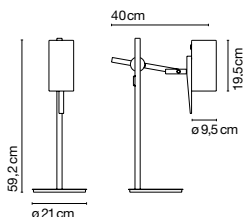

Range - Colección

Watch the video



SCANTLING is a term used to define the size to which a piece of wood or stone is measured and cut, derived from the name of an old unit of measurement. — *La palabra inglesa SCANTLING hace referencia a las dimensiones de la sección de una varilla de madera, y deriva de una herramienta de medida utilizada antiguamente.*



MARANGA

Christophe Mathieu, 2012



MARANGA is the name of a fruit, an imaginary fruit: exquisite, tempting, succulent. It reinterprets Scandinavian style in the essentiality of its shape and its rational use of lighting to generate a warm, comfortable atmosphere.

The shade is made up of 32 slice-like pieces which fit together to allow chinks of light to escape. This interplay of light and dark generates an effect which is rich in shades of light and prevents glare, while an opening at the bottom fitted with a diffuser gives out direct light downwards. — *MARANGA es nombre de fruta, de fruta inventada: exquisita, incitante, succulenta. Reinterpreta el estilo escandinavo en cuanto a la esencialidad de la forma y el uso racional de la iluminación para generar un ambiente cálido y confortable.*

La pantalla está formada por 32 piezas a modo de gajos que se intercalan entre sí dejando escapar resquicios de luz. Este juego de claroscuros genera un efecto rico en matices luminosos e impide el deslumbramiento, al tiempo que la abertura inferior provista de un difusor emite luz directa hacia abajo.



A shade made up of 32 polycarbonate sections, all attached to an upper chromed metal cover. Underneath there is a transparent polycarbonate diffuser with a prismatic engraving. The base and the stem are in lacquered metal. — *Pantalla compuesta de 32 piezas de policarbonato unidas entre sí a una tapa superior de metal cromado. En la parte inferior, un difusor de policarbonato transparente con grabado prismático. Base y tija de metal lacado.*

Structure · Estructura

- White · Blanco
- Umbra grey · Gris sombra (Ral 7022)
- Sand · Arena (Ral 7032)

Maranga M

- 3x E27 70W HSGSA/C/UB
- ⊖ 3x E27 18W FBT

Maranga S

- 2x E14 HSGSP/C/UB 42W
- ⊖ 2x E14 FBT 15W

Maranga M

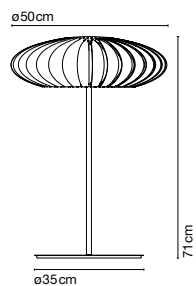

Maranga S

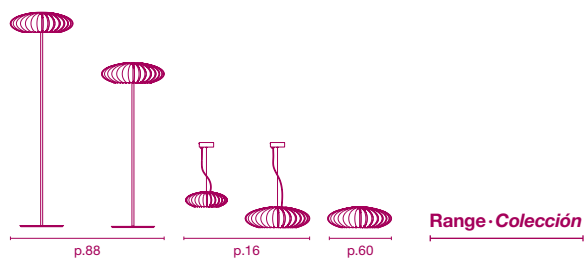
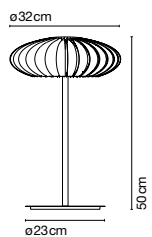

Watch the video



CLEA

Christophe Mathieu, 2006



A table lamp which is the result of the combination of the latest pop art trends and 21st century innovations in materials. Its design is based on the ergonomics, aesthetics and modernity of implements from the 60s. Made from injected polycarbonate, it can be supplied in the new following colours: orange, oyster white, pink, brown and anthracite. The switch is incorporated into the base. — *Esta lámpara de sobremesa es fruto de las mejores tendencias del pop y de la innovación de materiales del siglo XXI. Su diseño refleja la ergonomía, estética y modernidad de los objetos de los años 60.*

Fabricada en policarbonato inyectado se encuentra disponible en los siguientes nuevos colores: naranja, blanco perla, rosa, marrón y antracita. El interruptor está integrado en la base de la lámpara.



Injected polycarbonate structure. Aluminium reflector.
— *Estructura de policarbonato inyectado. Reflector de aluminio.*

- Anthracite · Antracita (Ral 8019)
 - Orange · Naranja (Ral 2000)
 - Grey brown · Gris marrón (Ral 7013)
 - White · Blanco (Ral 1013)
 - Pink · Rosa (Pantone 217C)
- G9 33W ECO (included · incluida)
 - G9 40W (included · incluida)

Clea

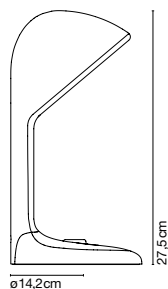

New following colours: Orange, oyster white, pink, brown and anthracite. — *Disponible en los siguientes nuevos colores: naranja, blanco perla, rosa, marrón y antracita.*



NOLITA

Joan Gaspar, 2008

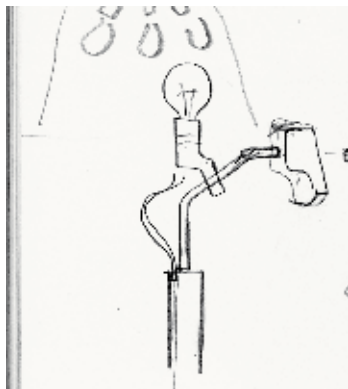

Close attention to the overall proportions is crucial in the sophistication and elegance of the NOLITA collection. The simplicity of its design and structure contrasts with the materials used, particularly the moulded polycarbonate for the shades with its different colours and textures. The NOLITA table allows a multiple finishings as per the colours of the diffuser in white, black or transparent, combined with the colours of the stem in black or aluminium. The shade tilts allowing different positioning of the light beam. This feature breaks the basic lamp's silhouette slightly but in no way compromises the elegance of the light. — *La colección NOLITA es sofisticada y elegante gracias a un trabajo exhaustivo en sus proporciones. Su sencillez formal y constructiva contrasta con los materiales utilizados, principalmente el policarbonato inyectado de las pantallas, y con sus diferentes colores y texturas. Hay que remarcar el brazo móvil que permite orientar la pantalla y el haz de luz. La silueta de lámpara básica se trastoca así levemente, pero sin ceder en elegancia.*

La versión NOLITA de sobremesa ofrece un juego de acabados múltiples ya que se puede combinar los colores del difusor, en blanco, negro o transparente, con los acabados de la tija, en aluminio o negro.



Conic diffuser with a double shade made of engraved polycarbonate. Anodized aluminium base and stem. — *Difusor cónico de doble pantalla de policarbonato con grabado. Fuste y base en aluminio anodizado.*

Structure · Estructura

- Black · Negro
- Aluminium · Aluminio

Shade · Pantalla

- Black · Negro
- White · Blanco
- Transparent · Transparente

Nolita M

- E14 42W HSGSP/C/UV
- E14 FBA 9W

Nolita M

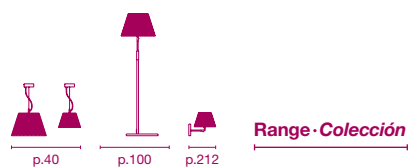
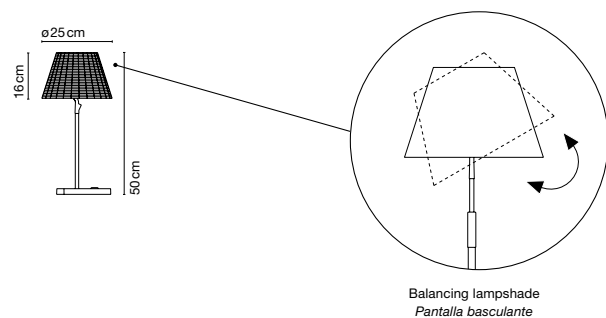



NOLITA COTTON

Joan Gaspar, 2009



This table version has a double-screen diffuser made of polycarbonate on the inside and natural cotton ribbons at the outside which creates a cosy lighting atmosphere. — *La versión NOLITA COTTON de sobremesa dispone de un difusor de doble pantalla con policarbonato en su interior y cintas de algodón crudo en el exterior creando así una confortable atmósfera de luz.*

Conic diffuser with a double shade made of polycarbonate on the internal part and raw cotton ribbons on the outside. Anodized aluminium base and stem. — *Difusor cónico de doble pantalla: policarbonato en su interior y cintas de algodón en el exterior. Fuste y base en aluminio anodizado.*

Structure · Estructura

- Black · Negro
- Aluminium · Aluminio

Shade · Pantalla

- Natural · Crudo

⦿ E14 42W HSGSP/C/UB

⦿ E14 FBA 9W

Nolita M

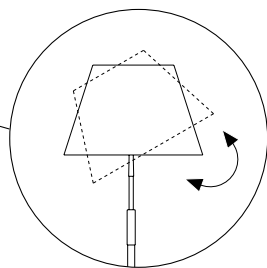
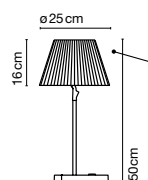

Balancing lampshade ·
Pantalla basculante

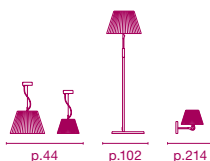

p.44

p.102

p.214

Range · Colección



MERCER

Javier M. Borrás & Joan Gaspar, 2006



MERCER is a beautiful and elegant lamp. The fusion of different materials achieves a spectacular result due to its pure cotton ribbed shade floating in a transparent blown glass structure.

The inner diffuser is available in natural or black cotton ribbons and, in a new modern and minimalistic version, in pearl white. — *La familia MERCER destaca por una sutil inversión de papeles: la pantalla de tela queda en el interior de una estructura de cristal soplado transparente. El difusor interior está disponible en cintas de algodón crudo o negro, y en una nueva versión moderna y minimalista, en blanco perla.*



Cotton shade that floats inside a transparent blown glass structure. Opal diffuser disc on the upper part. — *Pantalla de algodón que flota en una estructura de cristal soplado transparente. Disco difusor opal en la parte superior.*

- Natural · Crudo
- Black · Negro
- Pearl White · Blanco perla

Mercer dimmer

- ⦿ E27 105W HSGSA/C/UB
- ⦿ E27 FBT DIM 18W

Mercer Mini

- ⦿ G9 max. 40W / G9 33W ECO
- ⦿ G9 FBT 9W

Mercer M dimmer

- ⦿ E27 70W HSGSA/C/UB
- ⦿ E27 FBT DIM 18W

Mercer

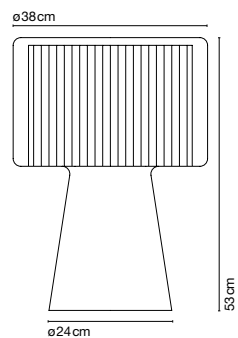

Mercer M

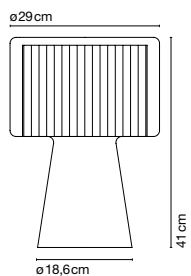

Mercer Mini

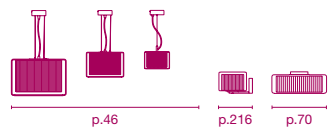
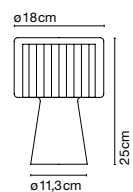

Range · Colección

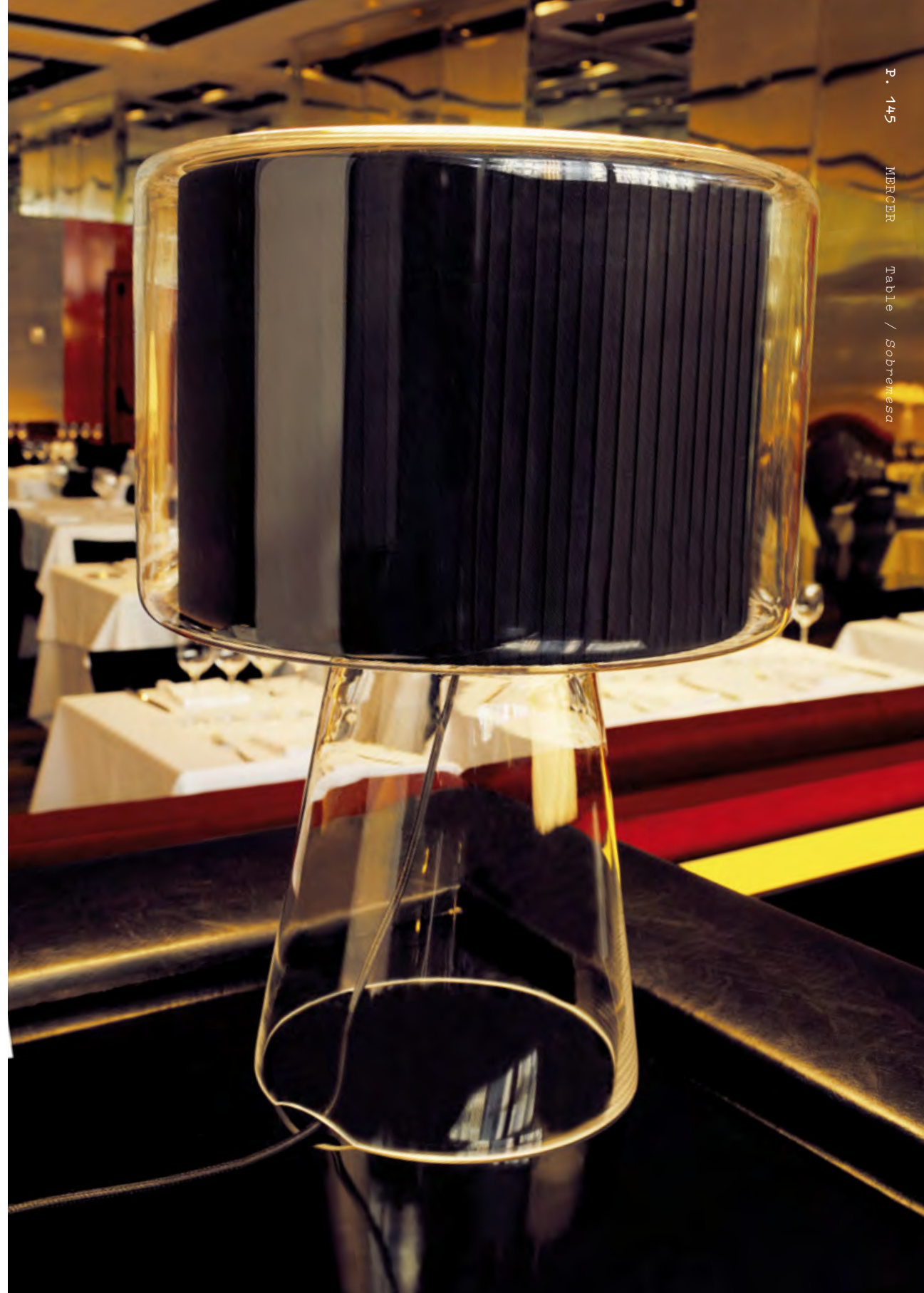

The blown glass that gives shape to the lamp is produced as one piece. — *El vidrio soplado que forma la lámpara está realizado en una sola pieza.*



The MERCER collection is now available in a new colour: Pearl white. — *La colección MERCER está ahora disponible en un nuevo color: blanco perla.*



ATILA

Joan Gaspar, 2006

ATILA is a brilliant variation on the flexible industrial lamp. It can be supplied with a variety of accessories: a cast aluminium base giving perfect stability, a clamp which acts as a pincer and the table and wall brackets.

ATILA incorporates the switch into the top cover, making it easy to turn on. In addition, its compact shade prevents the possibility of dazzling, creating a more solid unit and lending it quality and modernity. An adaptable structure which facilitates all the mechanical movements necessary to meet specific lighting needs. — ATILA supone una brillante interpretación de los flexos industriales. Está disponible con diversos accesorios: una base de fundición de aluminio que aporta una perfecta estabilidad, una mordaza que hace las veces de pinza y los soportes de mesa y pared.

El flexo incorpora el interruptor en la parte superior del cabezal, lo que facilita su encendido. Gracias a su pantalla compacta se evitan posibles deslumbramientos, creando un conjunto más sólido que le confiere calidad y modernidad. Una estructura constructiva que permite todos los movimientos mecánicos para adaptarse a las necesidades de iluminación.



Die cast aluminium stem. Polished aluminium shade with dome of transparent polycarbonate. — Fuste de aluminio extrusionado. Difusor de aluminio pulido con cúpula de policarbonato transparente.

● Polished aluminium · Aluminio pulido

E27 53W HSGSA/C/UB
E27 11W FBA

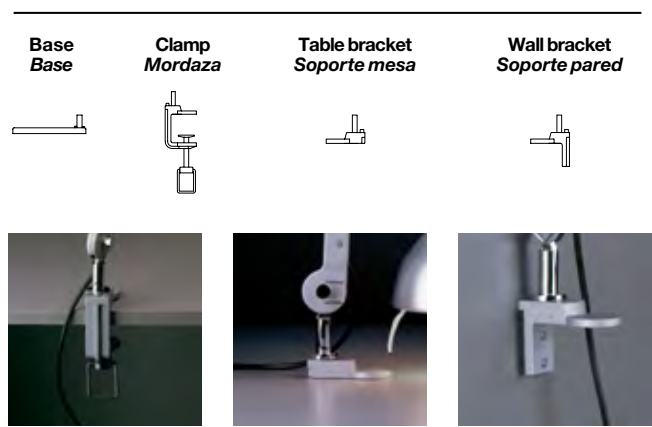
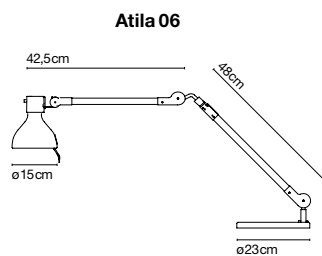

Range of positions
Variedad de posiciones

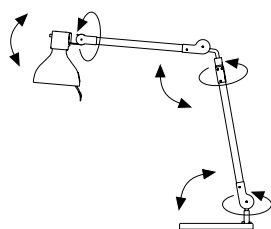

TOPOLINA

Christophe Mathieu, 2000

TOPOLINA pays a small homage to the classic metal clip-on lamp. In its revision of the classic model, TOPOLINA has perfected many technical and ergonomic changes: the aluminium reflector allows the lighting performance to be improved, thus absorbing the temperature generated by the bulb, which permits redirecting the beam of light. Available in transparent, blue, red, green and orange, this polycarbonate lamp is suitable as a reading companion, or as an element providing a special addition to any room. — *TOPOLINA rinde un pequeño homenaje a la clásica lámpara de pinza de metal. Como revisión del clásico, TOPOLINA ha perfeccionado la técnica y la ergonomía ya que el reflector de aluminio permite que el rendimiento lumínico mejore y se absorba la temperatura generada por la bombilla permitiendo dirigir la luz. Esta lámpara de policarbonato es idónea como compañera de lectura, como iluminador de un espacio que queremos destacar o sencillamente como elemento que dota de un cromatismo especial a alguna estancia.*



Transparent polycarbonate structure. Aluminium reflector.
— *Estructura de policarbonato transparente. Reflector de aluminio.*

- ⊙ Transparent · Transparente
- Red · Rojo
- Orange · Naranja
- Green · Verde
- Blue · Azul

💡 E14 40W (included · incluida)

Topolina

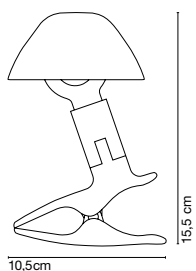

The bend of the clip-on makes it possible to fix the lamp to tubular shapes structures. — *La curvatura de la pinza facilita la sujeción de la lámpara a estructuras tubulares.*



COTTON

Javier M. Borrás, 1998



The COTTON family has hints of a classic lamp air with a contemporary design. This table lamp stylishly combines a square base with a metal cylindrical stem and a cotton-fabric ribbed lampshade which exudes a rich light with many textures and blends. It is available in three different sizes. — *La familia COTTON destila un aire de lámpara clásica con un diseño contemporáneo. Esta lámpara de sobremesa de formas estilizadas combina una estructura de base cuadrada con fuste cilíndrico metálico y una pantalla encintada de cinta de algodón crudo que proporciona una luz rica en matices y relieves. Está disponible en tres tamaños distintos.*



Base and stem in matte chromed metal. Raw cotton ribbed shade. — Fuste y base en metal cromado mate. Pantalla de cintas de algodón crudo.

Structure · Estructura

● Matte chrome · Cromo mate

Shade · Pantalla

● Natural · Crudo

Cotton S

○ E27 70W HSGSA/C/UB
⚡ 15W E27 FBT

Cotton M

○ E14 42W HSGSP/C/UB
⚡ 9W E14 FBT

Cotton Mini

⚡ G9 40W / G9 33W ECO

Cotton S

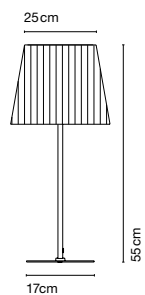

Cotton M

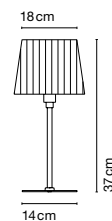

Cotton Mini

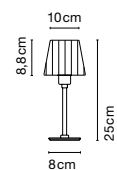

Range · Colección



SILO

Cristian Díez , 1996

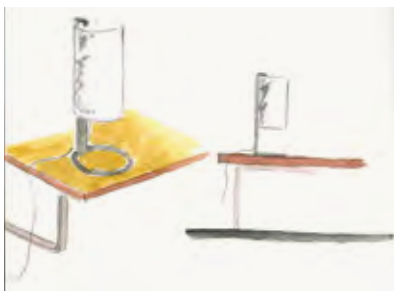

This simple and geometrically-shaped lamp is suitable to any place that requires a sober light without overwhelming.

The SILO lamp raises from a chrome-plated structure in which the base is a tube with a hollow circular shape which makes this lamp very light weight. The diffuser is a blown opal glass cylinder that reveals a very shady light with a superb quality. — *Esta lámpara de formas geométricas y sencillas es idónea para cualquier rincón que requiera una luz sobria sin estridencias.*

La lámpara SILO parte de una estructura de metal cromado cuya base es un tubo que forma un círculo hueco que la asienta y le proporciona ligereza. El difusor es un cilindro de cristal opal soplado que emite una luz tamizada y de gran calidad lumínica.

Chromed metallic structure. Diffuser of blown opal glass.
— **Estructura de metal cromado. Difusor de cristal opal soplado.**

Structure · Estructura

● Chrome · Cromo

○ E27 70W HSGSA/C/UB

□ E27 FBT 18W

Shade · Pantalla

○ White · Blanco

Silo S

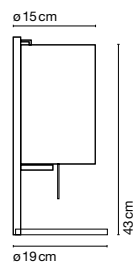

SILO works by means of a metal tube that comes up from the interior of the shade. — *SILO se acciona mediante un tirador metálico situado en el interior de la pantalla.*



**WALL
LAMPS**

**LÁMPARAS
DE PARED**

LEDTUBE

Daniel López, 2009

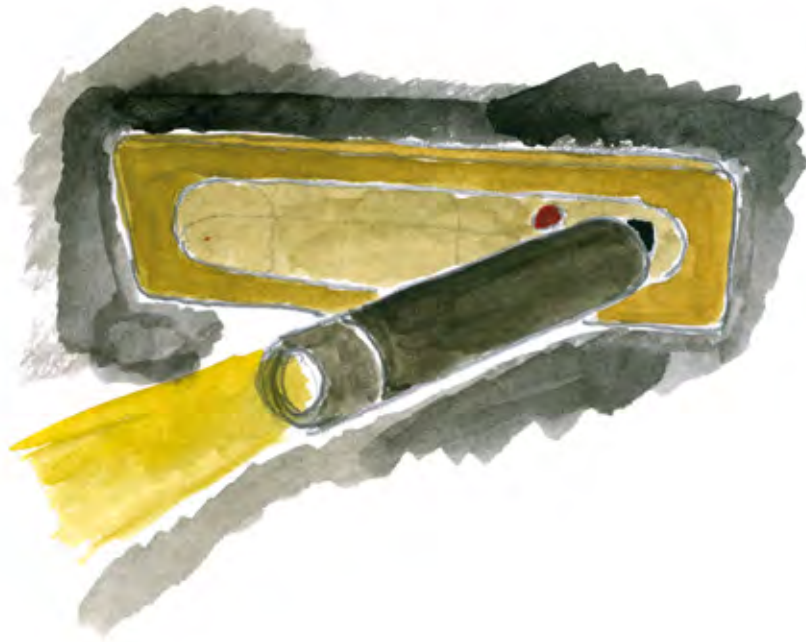

LEDTUBE is an orientable wall lamp which incorporates 3W 2700°K LED technology and a 24° lens that direct a sharp beam of light. It combines flat and cylindrical shapes made of injected aluminium and a frontal part made of transparent polycarbonate. Due to its architectural and functional design, this recessed version can be installed vertically or horizontally and it is suitable as a bedside lamp. — *LEDTUBE es un aplique orientable que incorpora tecnología LED de 3W 2700°K y una lente de 24° que dirige el haz de luz de forma nítida. Combina formas planas y cilíndricas realizadas en aluminio inyectado y una pieza frontal de policarbonato transparente. Por su diseño arquitectónico y funcional, esta versión empotrada se puede instalar en vertical u horizontal y es idóneo como lámpara de cabecera.*



Injected aluminium structure and a frontal piece of transparent polycarbonate. Incorporated press button to switch on or off when opening or closing the wall lamp. — *Estructura de aluminio inyectado y pieza frontal de policarbonato transparente. Pulsador incorporado para encender o apagar la fuente de luz al abrir o cerrar el aplique.*

- Aluminium · *Aluminio*
- White · *Blanco*
- Black · *Negro*

3W LED 700mA 95lm
(included / incluido)

Ledtube

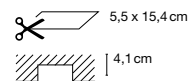
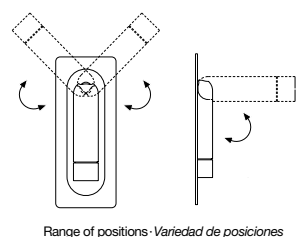
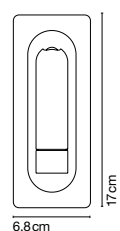

Light comes on automatically when LEDTUBE is opened and goes off when closed. — *La luz se enciende automáticamente al abrir el LEDTUBE y se apaga al cerrarlo.*

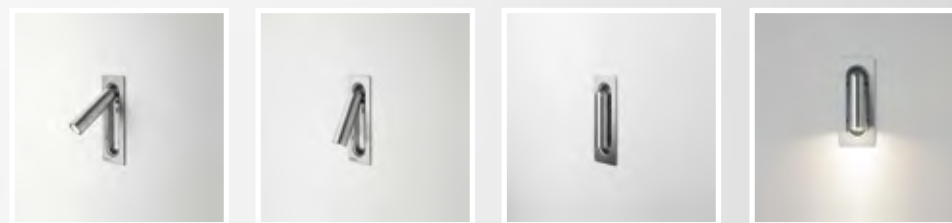

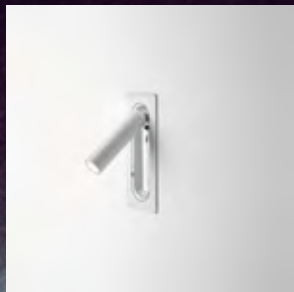
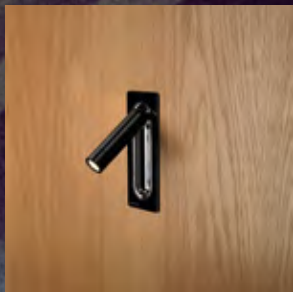
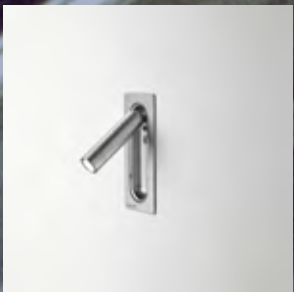

LEDTUBE R

Daniel López, 2012

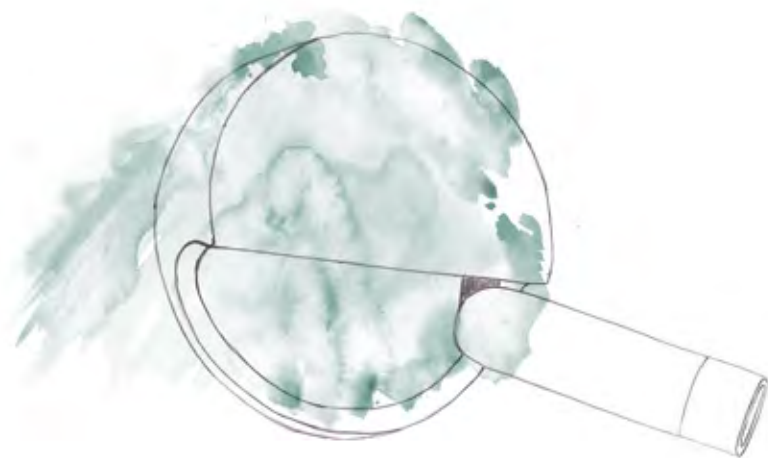

A new surface-mounted version of the LEDTUBE retains the LED technology of its predecessor now in a round casing. The orientable wall lamp is easy to use as the light comes on automatically when the LEDTUBE is opened out, and goes off when it is closed. The 180-degree rotation makes it ideal for installing on any bed head. — *Esta versión de superficie mantiene y amplía las virtudes de la colección LEDTUBE: es un aplique orientable con tecnología LED, sus formas orgánicas e intuitivas facilitan el uso ya que la luz se enciende automáticamente al abrir el LEDTUBE y se apaga al cerrarlo.*

Además, su rotación de 180° es idónea para instalar en cualquier cabecera de cama.



Injected aluminium structure and a frontal piece of transparent polycarbonate. Incorporated press button to switch on or off when opening or closing the wall lamp. — *Estructura de aluminio inyectado y pieza frontal de policarbonato transparente. Pulsador incorporado para encender o apagar la fuente de luz al abrir o cerrar el aplique.*

- Aluminium · *Aluminio*
- White · *Blanco*
- Black · *Negro*

3W LED 700mA 95lm
(included / *incluido*)

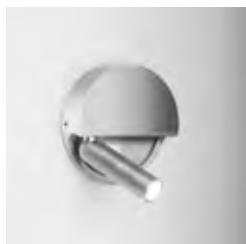
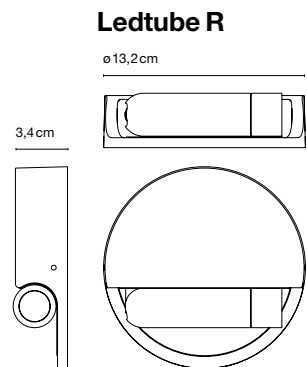

Ledtube R left ·
Ledtube R izquierdo

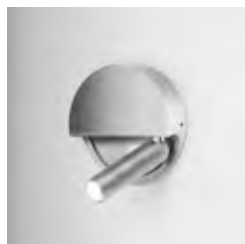

Ledtube R right ·
Ledtube R derecho

Incorporated press button to switch on or off when opening or closing the wall lamp. — *Pulsador incorporado para encender o apagar la fuente de luz al abrir o cerrar el aplique.*

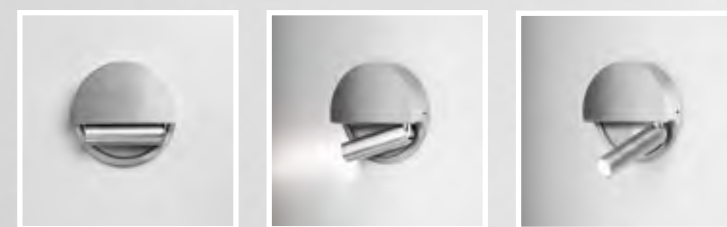

LEDCOMPASS

Joan Gaspar, 2012

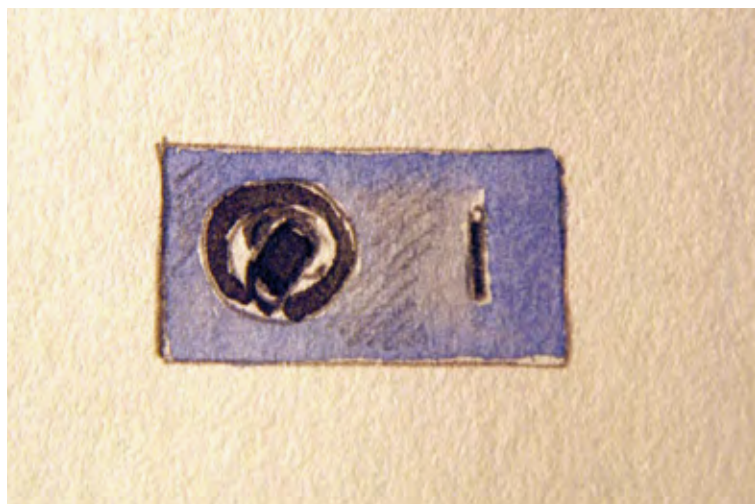

This orientable system of LED reading lights is based on a compass-type joint, which allows the light to be easily set to point in any direction. Inspired by the ventilation nozzles on airliners, the LEDCOMPASS collection is easy and intuitive to handle, as its LED technology enables users to aim the light without burning themselves. Clean and discreet in its lines, LEDCOMPASS is designed to function as a reading light or a light fitting in shelf units and corners which are to be highlighted. — *Este sistema orientable de lectores LED parte de una rótula de tipo compás que permite una fácil orientación del haz de luz en todos los sentidos. Inspirado en las salidas de aire de los aviones comerciales, la colección LEDCOMPASS tiene un manejo fácil e intuitivo ya que la tecnología LED permite que el usuario dirija el haz de luz sin quemarse. De líneas puras y discretas, LEDCOMPASS está pensado como lámpara de cabecera o punto de luz en estanterías y rincones que se quieran resaltar.*



Injected aluminium body, housing a swivel axis on the face, which facilitates the rotation through 360° of the cylinder containing a LED light. Built-in switch. — *Estructura de aluminio inyectado con un eje en la parte frontal que permite una rotación de 360° de un cilindro con LED. Interruptor incorporado.*

- Silver grey · Gris plata
- White · Blanco
- Black · Negro

3W LED 700mA 95lm
(included / incluido)

Ledcompass

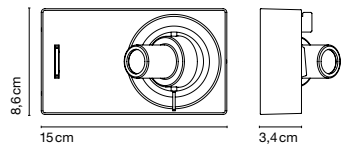

Ledcompass RSC

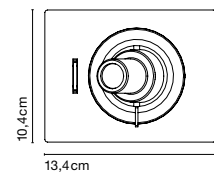

Ledcompass R 



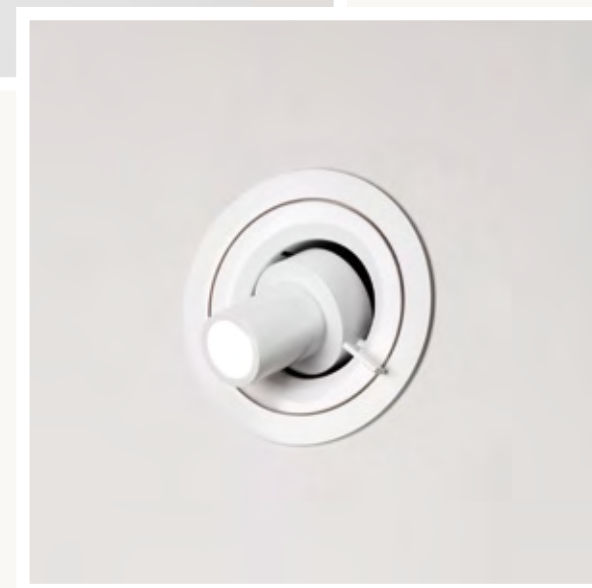
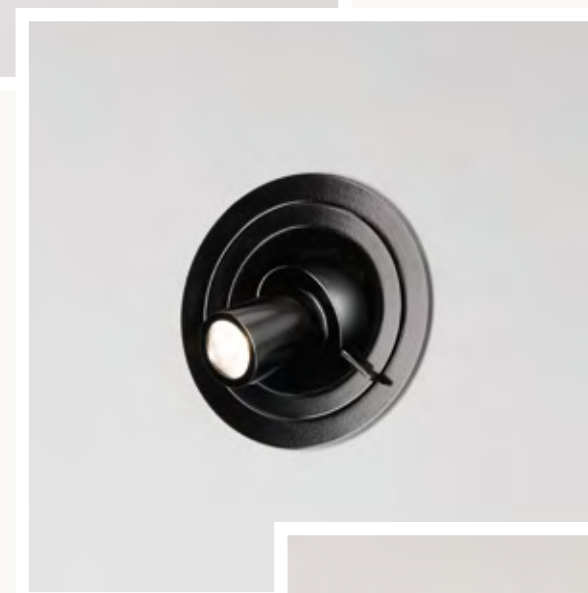

Inspired by the ventilation nozzles on airliners. — *Inspirado en las salidas de aire de los aviones comerciales.*



LEDPIPE

Joan Gaspar, 2005

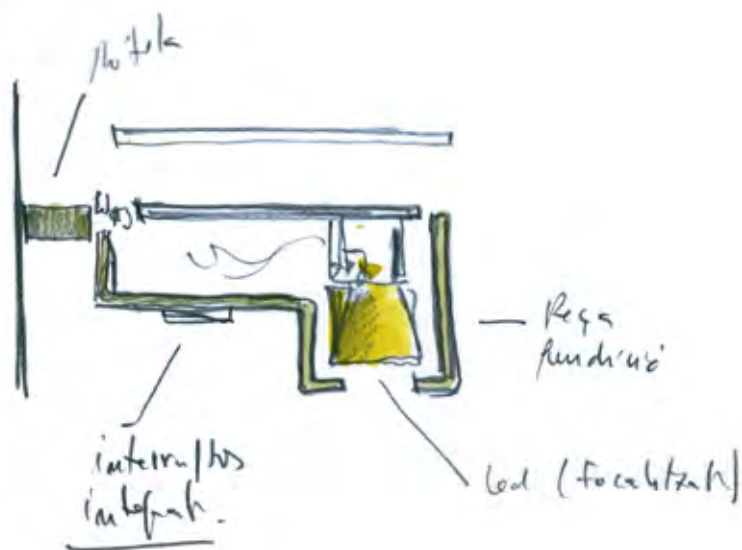

Suitable as a bedside reading light, one of its principal characteristics is its versatility, based on its movable arm and swivel head. Optimum light is produced to be used as a focus of direct illumination, without causing dazzling.

The LEDPIPE wall light is available in three different versions: with a long arm, as a surface wall lamp or built-in. — *Aplique de gran versatilidad gracias a su brazo móvil y a su cabezal orientable. Idónea como lámpara de cabecera, produce una iluminación óptima para ser utilizada como foco de luz directa sin que se produzcan deslumbramientos. LEDPIPE aplique está disponible en tres versiones: con brazo móvil, en superficie o empotrado.*



Structure and arm of painted metal. Injected aluminium diffuser with stainless steel lid. — Estructura y brazo de metal pintado. Difusor en inyección de aluminio con tapa de acero inoxidable.

- Silver grey · Gris plata
- White · Blanco
- Black · Negro

3W LED 700mA 95lm
(included / incluido)

Ledpipe

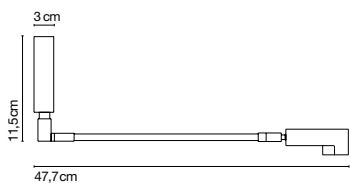

Ledpipe RSC

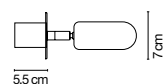
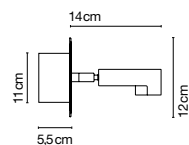

Ledpipe C

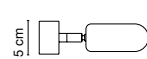
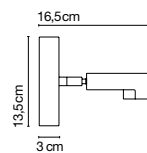

Range · Colección



SCANTLING

Mathias Hahn, 2010

A combination of basic geometric shapes and the use of wood together with metal give this family of lamps a homely appearance as well as a clearly defined personality.

SCANTLING is a term used to define the size to which a piece of wood or stone is measured and cut, derived from the name of an old unit of measurement. The interplay of the different elements used in its design gives this lamp an archetypal, almost graphic appearance. — *El ensamblaje de formas geométricas básicas y el uso de madera junto al metal, otorgan a esta familia de luminarias un aire próximo y a la vez una marcada personalidad. La palabra inglesa SCANTLING hace referencia a las dimensiones de la sección de una varilla de madera, y deriva de una herramienta de medida utilizada antiguamente. La evidencia de su juego constructivo procura a esta lámpara una cierta imagen arquetípica, casi gráfica.*

Lacquered iron stem and base. Solid oak arm supports a lacquered aluminium shade. The switch is built into the plaque on the wall. — Tija y base de hierro lacado. Brazo de roble macizo que sostiene un difusor de aluminio. El interruptor está incorporado en la placa de la pared.

Structure · Estructura

- Stone grey-oak · Gris piedra-roble
- White-oak · Blanco-roble

Shade · Pantalla

- Stone grey · Gris piedra
- White · Blanco

⦿ E27 FBT 18W

⦿ E27 PAR20 50W

Scantling A

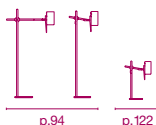
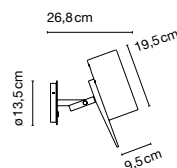

Range · Colección

Watch the video



TAM TAM

Fabien Dumas, 2012

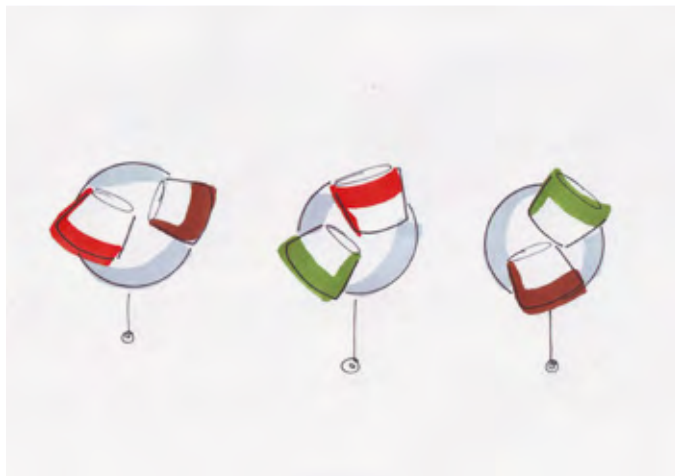

Here they are, the new members of the TAM TAM family: A wall version with one or two shades (22cmØ) with a full rotation of 360°. They fit your environment, spreading light wherever you want. The single-shade version is suitable for use as a bedside lamp, featuring a switch at the bottom, and the two-shade version invites you to install it in corridors or just to light up spaces.

They may be tiny but they are just as mighty as their big brothers. They are smart, attractive and will bring a smile to your face. — *Aquí está, el nuevo miembro de la familia TAM TAM: esta versión de pared posee con una o dos pantallas de 22cmØ que pueden orientarse 360° en cualquier posición. Encajan en el ambiente iluminando donde se quiera. La versión de una sola pantalla es idónea como lámpara de cabecera con interruptor incorporado, y la versión de dos pantallas es adecuada para instalar en pasillo o iluminar espacios.*

Quizás son pequeñas pero tan poderosas y espectaculares como sus hermanas mayores. Son inteligentes, agudas, encantadoras y dibujarán una sonrisa en la cara.

Versatile and cheerful, TAM TAM A invites you to play with colours: Black, white, orange, brown, green or sand, with the base plate always in white. — *Versátil y alegre, TAM TAM A invita a jugar con los colores, a escoger entre negro, blanco, naranja, marrón, verde y arena con la placa de la pared siempre en blanco.*

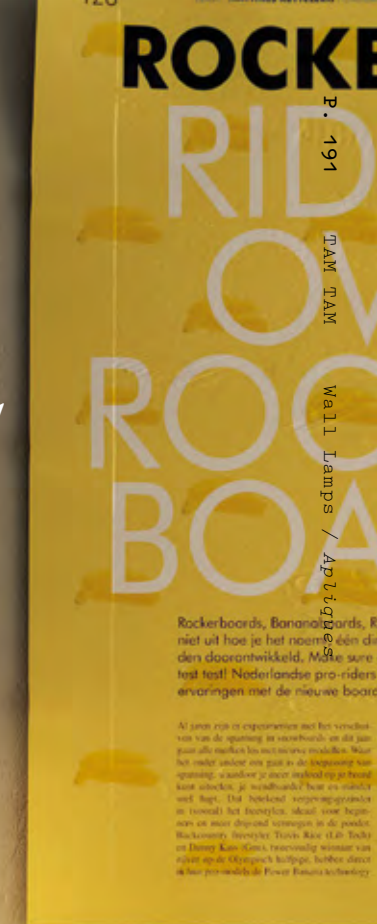

White lacquered metal plate. Shade made of lacquered aluminium with an opalescent methacrylate diffuser over the open end.
— Placa de metal lacado blanco. Pantalla de aluminio lacado con un difusor de metacrilato opal.

Shade · Pantalla

- Black · Negro
- White · Blanco (Ral 1013)
- Orange · Naranja (Ral 2000)
- Grey brown · Gris marrón (Ral 7013)
- Green · Verde (Ral 6025)
- Sand · Arena (Ral 7032)

Base

- White · Blanco (Ral 1013)

Tam Tam A

- ⚡ E14 15W FBT
- ⚡ E14 42W HSGSP/C/UB

Tam Tam A2

- ⚡ 2x E14 15W FBT
- ⚡ 2x E14 42W HSGSP/C/UB

Tam Tam A

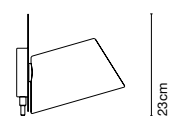
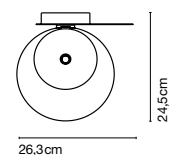
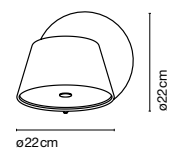

Tam Tam A2

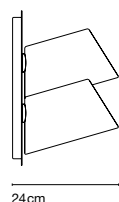
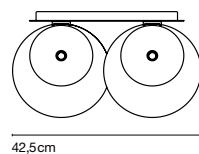
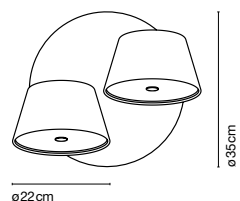

p.2

Range · Colección

Watch the video



SCENE

Joan Gaspar, 2012



A wall lamp, which provides indirect light, SCENE lights up the wall in a neutral, discreet manner, which combines functionality and comfort. As if it were a lit stage, SCENE features an opening at the front which creates a halo of light to stage this theatrical effect. Made from injection-moulded aluminium, it is available in black, white or silk grey, with LED, fluorescence or halogen light sources. — *Lámpara de pared de luz indirecta, SCENE ilumina la pared de forma neutra y discreta, con funcionalidad y confort. Como si fuera el escenario iluminado de un pequeño teatro, SCENE dispone de una cavidad frontal dotada de un halo de luz que crea este efecto teatral.*

Realizada en aluminio inyectado, está disponible en blanco, gris seda o negro, y las fuentes de luz en LED, fluorescencia o halógena.

Structure in injection-moulded aluminium. — Estructura de inyección de aluminio pintado.

- White · Blanco (Ral 9003)
- Silk grey · Gris seda (Ral 7044)
- Black · Negro (Ral 9005)
- R7s 120W ECO 114mm
- G24 q-3 TC-DEL 26W
- LED 14W 900lm (included / incluido)

Scene

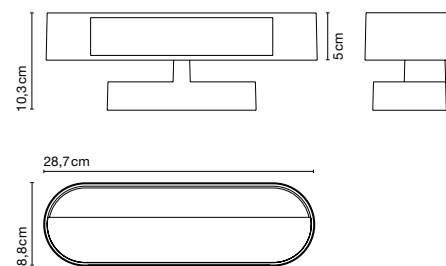



DISCOCÓ

Christophe Mathieu, 2012



Attractive and decorative, DISCOCÓ has become a resounding success, with one foot in Scandinavian design and the other in Mediterranean style. Its complex simplicity and evocative play of light and shade make this lamp ideal to illuminate and enrich a setting.

The collection is expanded with this new wall sconce, also available in white, chocolate, turquoise blue, sand and black-gold. — *Atractiva y ornamental, DISCOCÓ se ha convertido en un éxito rotundo con un pie en el diseño escandinavo y otro en el mediterráneo. Su compleja sencillez y el sugerente juego de luces y sombras hacen de esta lámpara un objeto de luz idóneo para enriquecer el ambiente.*

La colección se amplía con esta nueva versión de pared, disponible también en blanco, chocolate, azul turquesa, arena y negro-oro.



Opaque discs made in moulded ABS. Chromed semi-sphere. — Discos opacos de ABS inyectado. Semiesfera cromada.

- White · Blanco
- Sand · Arena (Ral 7032)
- Chocolate (Ral 8017)
- Turquoise · Turquesa (Ral 6034)
- Black-gold · Negro-oro

2x E14 FBT 15W

Discocó A

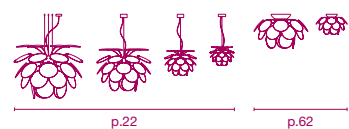
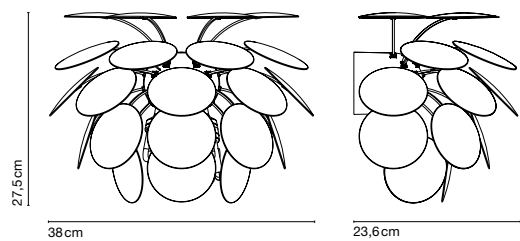

p.22

p.62

Range · Colección

Watch the video



CONTINUA

Christophe Mathieu, 2010



Conceived as a modular system for producing lengthways strips of light, it is designed to be included in any surroundings using decorative resources. The frontal profile of transparent polycarbonate makes it possible to slot in an exchangeable film made of translucent materials or opaque black finish, which generates indirect light. It is possible to personalise the film and combine it with any type of wall finish (colours, wallpaper, wood or fabric). It can be installed as isolated modules, or in continuous strips to illuminate corridors, headboards for beds, etc. Its multifaceted design also allows it to be used as a base for illuminated signs, and includes an IP44 model, which is ideal for bathrooms. — *Ideado como sistema modular para generar franjas longitudinales de luz, es un diseño que contempla su integración en cualquier ambiente mediante recursos decorativos.*

El perfil frontal de policarbonato transparente permite insertar una película intercambiable con materiales translúcidos o de naturaleza opaca, lo que genera luz indirecta. El sistema hace viable personalizar la pantalla y unificarla con cualquier acabado de pared (color, papel pintado, madera, tejido). Puede instalarse por módulos aislados o construir líneas de luz continua para iluminar pasillos, cabezales de cama, etc. Su carácter polifacético permite convertirla también en base luminosa para señalética, y es idónea en baños ya que está disponible una versión IP44.

The system makes it possible to personalise the film and combine it with any type of wall finish (colours, wallpaper, wood or fabric). — *Este sistema hace viable personalizar la pantalla y unificarla con cualquier acabado de pared (color, papel pintado, madera o tejido).*

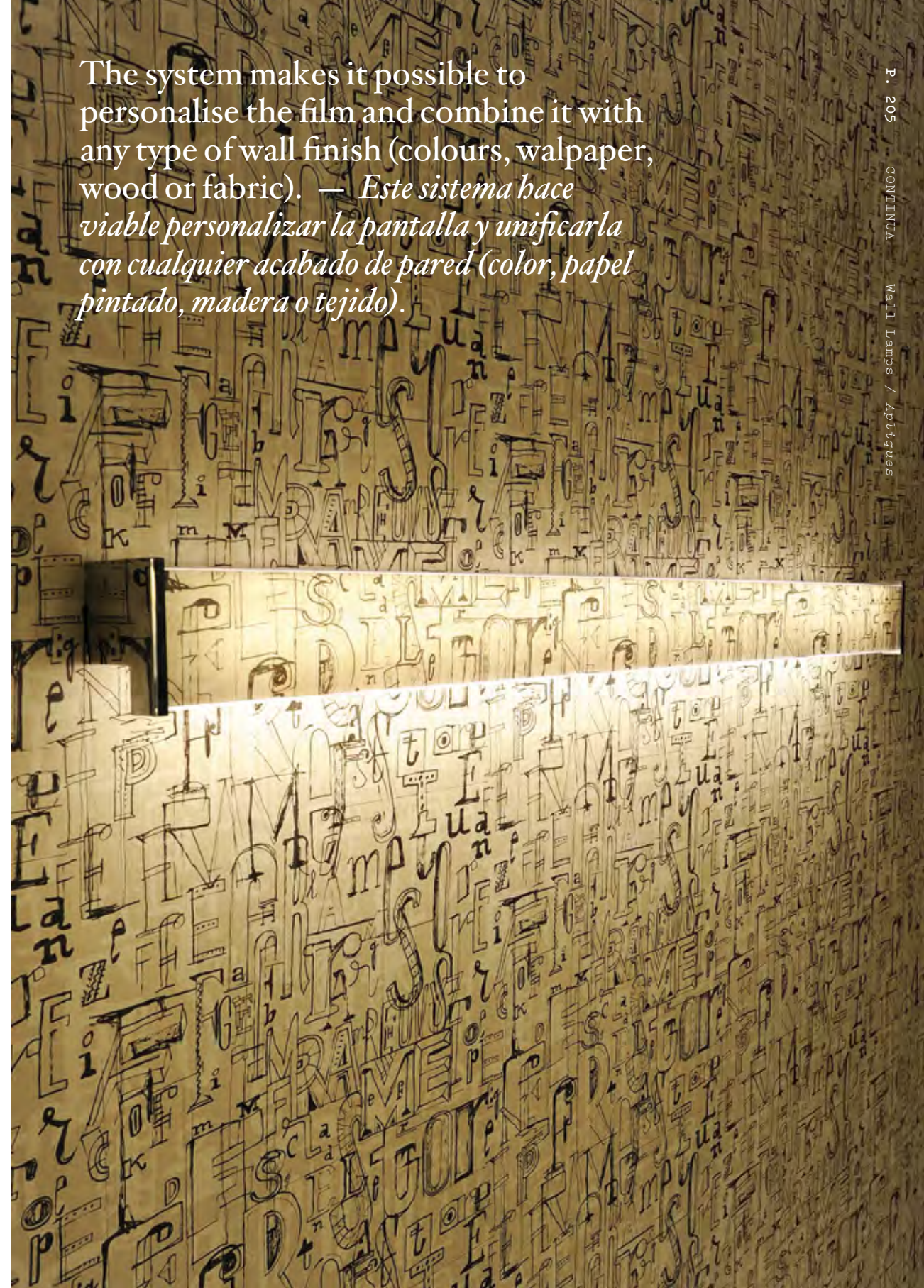

Extruded anodized aluminium structure and polycarbonate profile that allows exchanging of diffusers of different texture. Chromed aluminium side over. — *Estructura extrusionada de aluminio anodizado brillante y perfil de policarbonato transparente que permite introducir un difusor intercambiable de distintas texturas. Tapas de aluminio cromado.*

Structure · Estructura

○ Transparent-chrome · Transparente-cromo

Diffuser · Difusor

● White linen · Lino blanco

● Tobacco · Tabaco

● Natural · Crudo

● Black · Negro

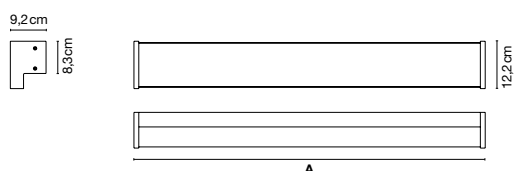
Continua**A**

32,5 cm

60,5 cm

90,5 cm

120,5 cm

150,5 cm

⇐ 2G11 18W

⇐ T5 14/24W

⇐ T5 21/39W

⇐ T5 28/54W

⇐ T5 35/49/80W

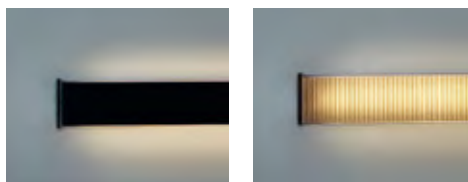
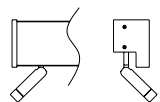
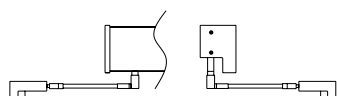
Continua + Ledtube**Continua + Ledpipe****Joint kit
Kit de unión**

IP44

This system makes it possible to connect modules of different lengths to create a line of continuous lighting. — *Es un sistema que permite unir módulos de distintas longitudes para conseguir líneas de luz continua.*



IP44

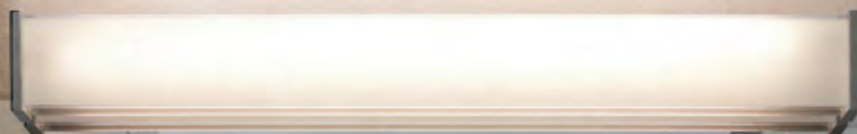

When used as lighting for headboards, an LED reading lamp can be included. — *Como aplique en cabecera de cama está preparada para incorporar una luz LED de lectura.*



NOLITA

Joan Gaspar, 2008

Close attention to the overall proportions is key to the sophistication and elegance of the NOLITA collection. The simplicity of its design and structure contrasts with the materials used, particularly the moulded polycarbonate for the shades with its different colours and textures. NOLITA wall offers a multiple finishings of the diffuser in white, black or transparent, can be combined with the colours of the structure in black or aluminium. — *La colección NOLITA es sofisticada y elegante gracias a un trabajo exhaustivo en sus proporciones. Su sencillez formal y constructiva contrasta con los materiales utilizados, principalmente el policarbonato inyectado de las pantallas con sus diferentes colores y texturas.*

La versión NOLITA aplique ofrece un juego de acabados múltiples ya que se pueden combinar los colores del difusor, en blanco, negro o transparente, con los acabados de la estructura, en aluminio o negro.

Conic diffuser with a double shade made of engraved polycarbonate. Aluminium structure. — Difusor cónico de doble pantalla de policarbonato con grabado. Estructura en aluminio.

Structure · Estructura

- Aluminium · Aluminio
- Black · Negro

Shade · Pantalla

- Transparent · Transparente
- White · Blanco
- Black · Negro

○ E14 42W HSGSP/C/UB

○ E14 FBA 9W

Nolita A

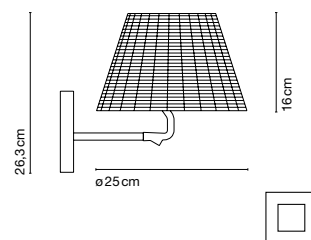

Range · Colección



NOLITA COTTON

Joan Gaspar, 2009

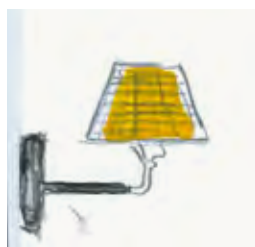

This wall version has a double-screen diffuser made of polycarbonate on the inside and natural cotton ribbons on the outside which creates a cosy lighting atmosphere. — *La versión NOLITA COTTON applique dispone de un difusor de doble pantalla con policarbonato en su interior y cintas de algodón crudo en el exterior creando así una confortable atmósfera de luz.*

Conic diffuser with a double shade made of polycarbonate on the inside part and raw cotton ribbons on the outside. Aluminium structure. — Difusor cónico de doble pantalla: policarbonato en su interior y cintas de algodón en el exterior. Estructura en aluminio.

Structure · Estructura

- Aluminium · Aluminio
- Black · Negro

Shade · Pantalla

- Natural · Crudo

○ E14 42W HSGSP/C/UB

◐ E14 FBA 9W

Nolita Cotton A

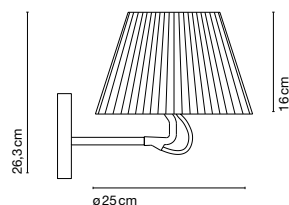

Range · Colección



MERCER

Javier M. Borrás & Joan Gaspar, 2009



The fusion of different materials achieves a spectacular result as its raw cotton ribbioned shade floats in a transparent blown glass structure, so that the fabric provides a diffused and delicate light that mixes with the sparkling blown glass lamp.

The inner diffuser is available in natural or black cotton ribbons and, in a new modern and minimalistic version, in pearl white. — *La fusión de materiales de distinta naturaleza consigue un producto de gran espectacularidad ya que su pantalla de cinta de algodón flota en una estructura de cristal soplado transparente. Así, la luz delicada y difusa que proporciona el tejido se mezcla con centelleos de luces emitidos por el cristal brillante y transparente de la lámpara. El difusor interior está disponible en cinta de algodón crudo o negra y en una nueva versión más moderna y minimalista en blanco perla.*



Chromed iron wall bracket. Cotton shade that floats inside a transparent blown glass structure. Opal diffuser disc on the upper part. — Soporte de hierro cromado. Pantalla de algodón que flota en una estructura de cristal soplado transparente. Disco difusor opal en la parte superior.

Structure · Estructura

- Chrome · Cromo

Shade · Pantalla

- Natural · Crudo
- Black · Negro
- Pearl White · Blanco perla

- ⦿ E14 42W HSGSP/C/UB
- ⦿ E14 FBA 9W

Mercer A

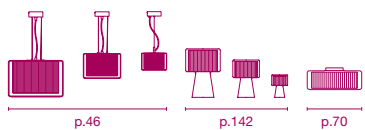
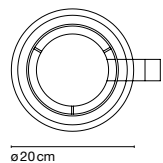
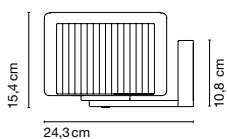

Range · Colección





P. 220

MERCEUR

Wall Lamps / Appliques



P. 221

MERCEUR

Wall Lamps / Appliques

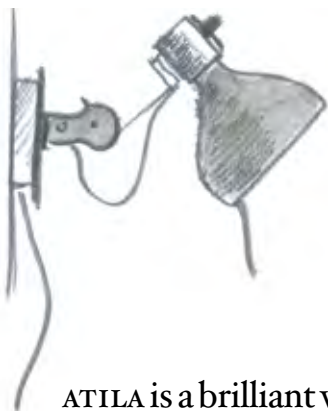

ATILA

Joan Gaspar, 2006



ATILA is a brilliant variation of the flexible industrial lamp. Suitable as a bedside lamp, it incorporates the switch into the top cover, making it easy to turn on. In addition, its compact shade prevents the possibility of dazzling, creating a more solid unit and lending it quality and modernity. The joint's adaptable structure facilitates all the movements. — *ATILA supone una brillante interpretación de los flexos industriales. Idónea como lámpara de cabecera, incorpora el interruptor en la parte superior del cabezal, lo que facilita su encendido. Además, gracias a su pantalla compacta se evitan posibles deslumbramientos, creando un conjunto más sólido que le confiere calidad y modernidad. La estructura constructiva de la rótula permite todos los movimientos.*

Base in zamac and stainless steel. Polished aluminium shade with dome of transparent polycarbonate. — Base en zamac y acero inoxidable. Difusor de aluminio pulido con cúpula de policarbonato transparente.

● Polished aluminium - Aluminio pulido

○ E27 53W HSGSA/C/UB

○ E27 11W FBA

Atila 06 A

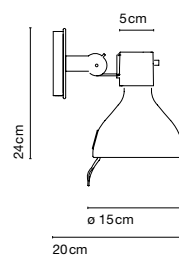

Range - Colección

p.150



COTTON

Javier M. Borrás, 1998

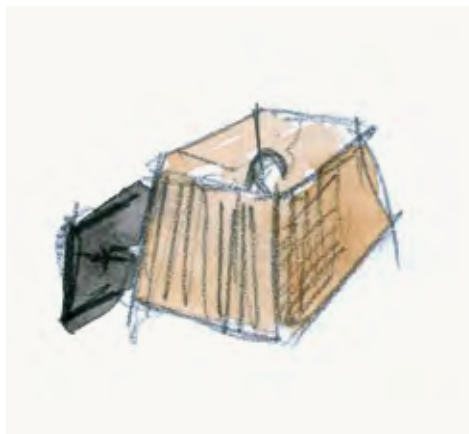

The COTTON wall lamp offers a very soft and cosy light. This is due to a ribboned shade made of raw cotton and to the incandescent bulb inside. — *El aplique COTTON ofrece una luz suave y confortable gracias a la pantalla de algodón crudo encintada y a su luz incandescente.*

Structure of matte chromed metal. Raw cotton ribboned shade.
— *Estructura en metal cromado mate. Pantalla de cintas de algodón crudo.*

Structure · Estructura

● Matte chrome · Cromo mate

Shade · Pantalla

● Natural · Crudo

○ E27 70W HSGSA/C/UB

⊞ 18W E27 FBT

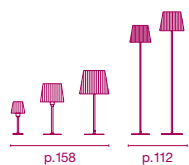

Range · Colección

Cotton A

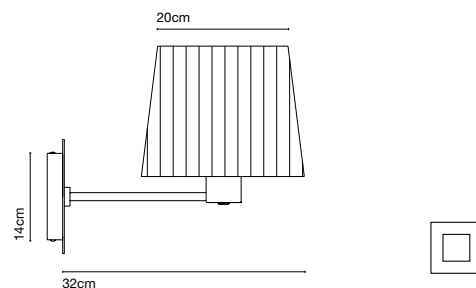

204

Marset Team, 1985

This wall lamp is primarily functional and can be placed anywhere a direct light focus is needed. Its design has been devised to be practical, efficient and modern.

The cylindrical diffuser opened on one side, has a thin lever allowing movement so that the light may be directed where needed. It is ideal for lighting small places that do not need a big source of light. Due to its timeless design it can be combined perfectly with any kind of materials or styles. — *Este aplique es eminentemente funcional ya que gracias a su diseño permite su instalación en lugares que necesitan de un foco de luz directo. Su diseño está pensado para ser práctico, eficaz y moderno.*

Con un difusor de forma cilíndrica, abierto por un lado, va acompañado de un fino tirador que permite direccionar la luz. El brazo extensible le otorga una gran movilidad. Es por su diseño atemporal perfectamente combinable con todo tipo de materiales y estilos.

Structure, arm and diffuser in chromed brass. — Estructura, brazo y difusor de latón cromado.

● Matte chrome · Cromo mate

204 
 GY6,35 35W 12V

204 LED
 2x LED 3W (included · incluida)

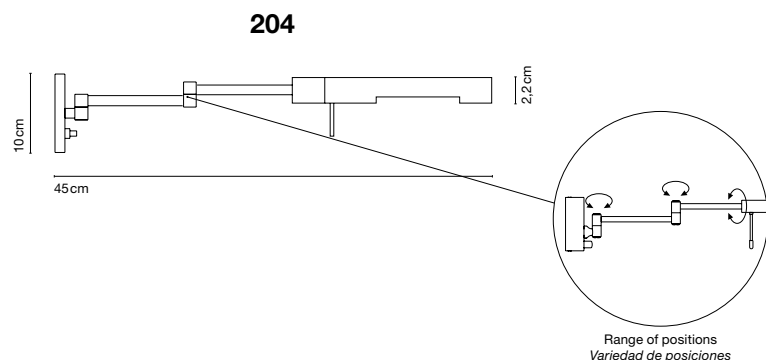

ZOO

Lagranja, 2008

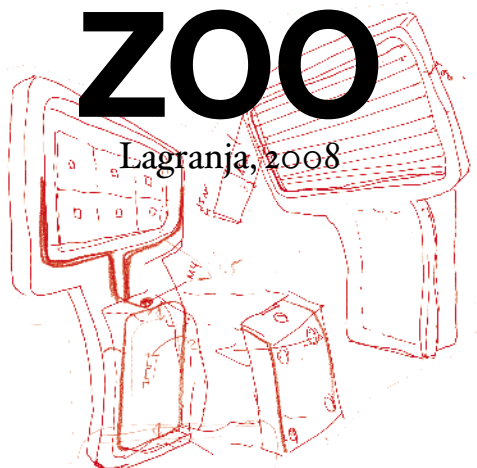

ZOO is a wall fitting made of translucent injected polycarbonate with modern aesthetics. Its rotating diffuser allows for direct or indirect light. Three watt LED light source. Available in aluminium, white and orange finishes. — *ZOO es un aplique realizado en policarbonato inyectado translúcido que le confiere una estética moderna y ligera. El difusor rotatorio permite dirigir el haz de luz iluminando de forma directa o indirecta. La fuente de luz utilizada está compuesta por 3 LEDs de 3W. Disponible en aluminio, blanco y naranja.*

Structure in translucent injected polycarbonate. Heat sink component made from injection moulded, lacquered aluminium. — *Estructura de policarbonato transparente inyectado. Elemento disipador de temperatura de aluminio inyectado lacado.*

- Aluminium · Aluminio
- White · Blanco
- Orange · Naranja

3x LED 3W

Zoo

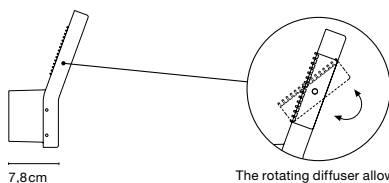
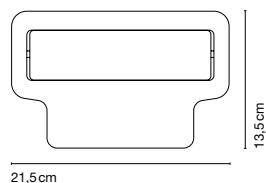

The rotating diffuser allows for direct or indirect light.
El difusor rotatorio permite dirigir el haz de luz iluminando de forma directa o indirecta.



FISCHT
FRISCHE
FISCHE
FRISCHE
FISCHE
FISCHT
FISCHERS
FRITZE

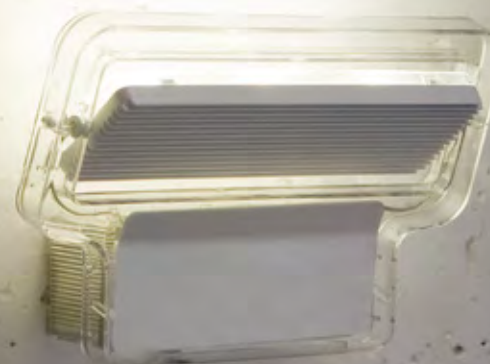
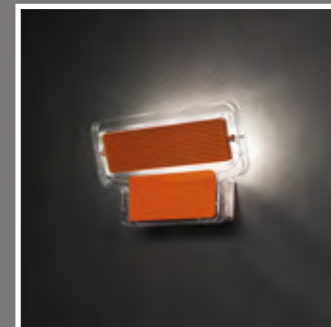

BIG MOUSE

Joan Gaspar, 2006

BIG MOUSE is one of those wall lamps which stands out because of its size, versatility and materials which give it an outstanding appearance. It is remarkable the brilliant lighting effect produced by the superimposition of the polycarbonate components of the shade: An engraved transparent body over a translucent one which fit perfectly into the aluminium frame. The lamp is available in single and double versions. — *BIG MOUSE es uno de esos apliques que destacan por su tamaño, versatilidad y por los materiales, que le confieren un aspecto contundente. Es interesante el efecto brillante de luz que produce la superposición de los dos cuerpos de policarbonato de la pantalla: un cuerpo transparente grabado sobre uno translúcido que encajan perfectamente en la estructura de aluminio. Disponible en versión sencilla y doble.*

Aluminium structure. Polycarbonate double-screen shade: translucent on the inside and engraved transparent on the outside. — Estructura de aluminio. Doble pantalla de policarbonato: translúcido en su interior y transparente grabado en el exterior.

Structure · Estructura
● Silver grey · Gris plata

Shade · Pantalla
○ White · Blanco

A.06
○ E27 42W HSGSA/C/UB
☐ E27 FBT 18W

2.06
○ 2x E27 42W HSGSA/C/UB
☐ 2x E27 FBT 18W

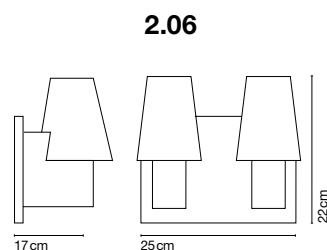
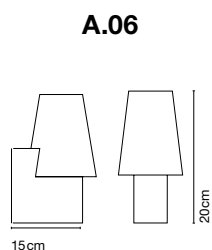

SILO

Cristian Díez, 1996



With reminiscences of the 50s, the SILO wall lamp raises from a minimal metal structure of chrome metal and a cylindrical diffuser made of opal glass with a high lighting efficiency. Its geometrical and discreet shape emits a diffused and pure light of great quality. There is also a shorter version, the SILO C. — *Con reminiscencias de los años 50, el aplique SILO parte de una estructura mínima de metal cromado y un difusor cilíndrico de cristal opal de gran eficacia lumínica. Sus formas geométricas y discretas destilan una luz difusa tamizada y de gran calidad.*



Chromed metallic structure. Diffuser of blown opal glass.
– Estructura de metal cromado. Difusor de cristal opal soplado.

Structure · Estructura

- Chrome · Cromo

Shade · Pantalla

- White · Blanco

Silo A

- E27 70 W HSGSA/C/UB
- ⚡ E27 FBT 18W

Silo C

- E27 70W HSGSA/C/UB
- ⚡ E27 FBT 15W

Silo A

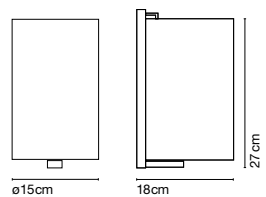

Silo C

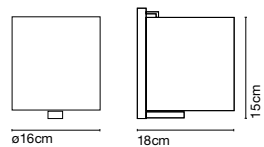

VIGA MINI

Joan Gaspar, 1992

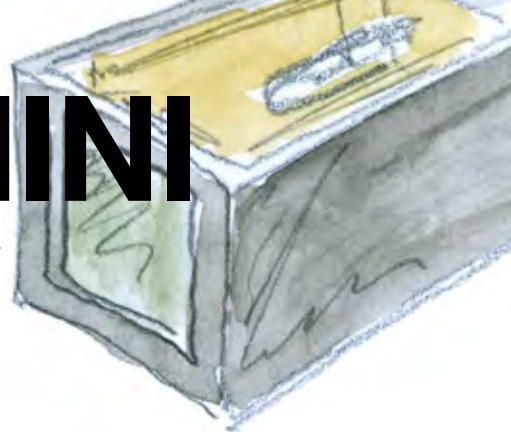

A geometrical element that looks for maximum integration within the surrounding architecture. The white metallic structure gives this lamp a conclusive image. The light escapes from the front and from the opening in the top, which allows the soft direct light to pass through generating an indirect halo above it. — *Un elemento geométrico que busca el máximo mimetismo en la arquitectura interior tal como su nombre indica. La viga como fundamento en la estructura arquitectónica. El bloque metálico le otorga una imagen contundente. La luz se escapa a través del cristal frontal y por la abertura inferior creando una suave luz directa, y por la parte superior generando un halo de luz indirecta.*

Chromed or painted metal diffuser with a hole on the lower part and white satin glass at the front. — Difusor de metal pintado o cromado con una hendidura en su parte inferior y un cristal translúcido en la parte frontal.

Structure · Estructura

- White · Blanco
- Chrome · Cromo
- Matte chrome · Cromo mate

Diffuser · Difusor

- White · Blanco

⏏ G9 40W

Viga Mini

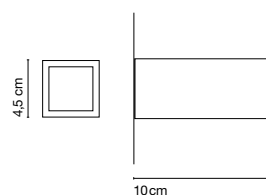

MOMA

Christophe Mathieu, 1999



The design of the MOMA wall lamp is clearly architectural, sober and functional. It can be installed horizontally or vertically. MOMA is specially projected to light up elements that need direct and uniform light. Made of cast aluminium, it is available in a silver grey finish. — *El diseño del aplique MOMA es claramente arquitectural de aspecto sobrio y funcional. Se puede instalar en posición horizontal o vertical. Especialmente proyectada para iluminar elementos necesitan luz directa y uniforme. Realizada en inyección de aluminio, lacada en gris plata.*



Base, arm and diffuser in injected aluminium. Diffuser made of borosilicate glass. — Base, brazo y difusor en inyección de aluminio. Difusor en cristal de borosilicato.

● Silver grey · Gris plata

☐ 3x G4 20W

3x LED 3W (included · incluidas)

Moma

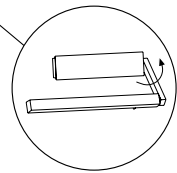
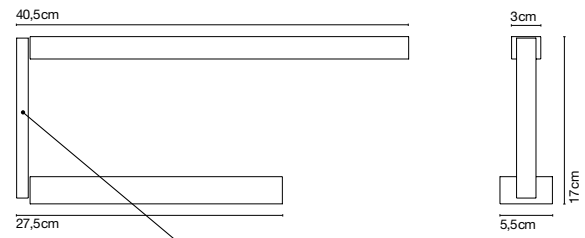

Range of positions
Variedad de posiciones



MANHATTAN T5

Joan Gaspar, 2005

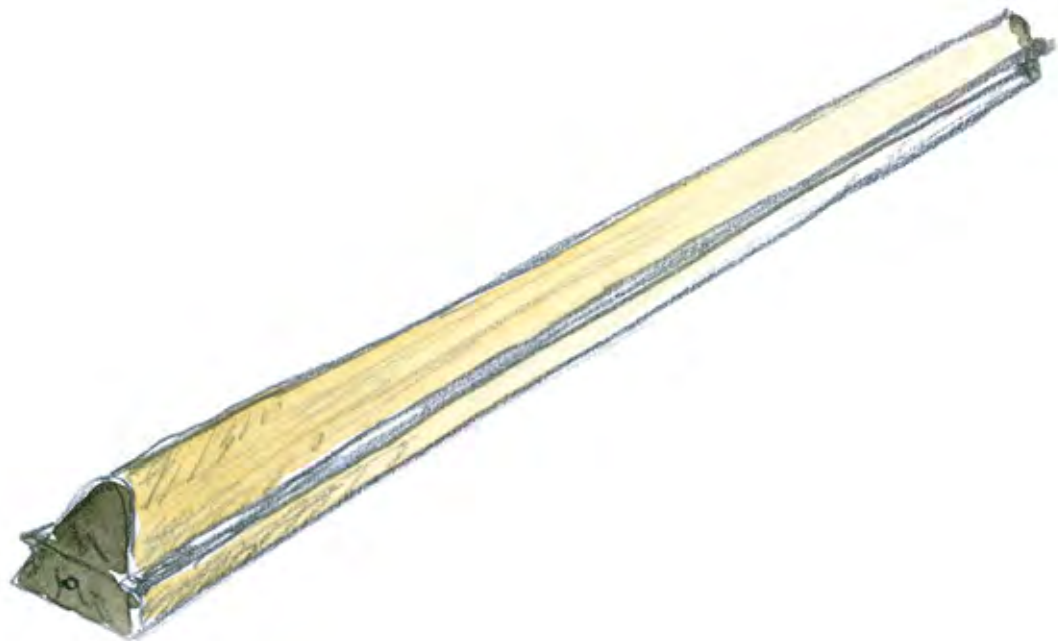

The main virtue of this wall lamp, suitable for bathroom, is the rationality of its design and its ornamental free look. It has been equipped internally with a silk-screened polycarbonate film to complement the high quality of the t5 fluorescent light source. The shape makes the lamp suitable for vertical or horizontal installation. — *La característica más destacable de este aplique de baño es la racionalidad de su diseño y su estética libre de ornamentos. Se le ha dotado interiormente de una película de policarbonato serigrafiado para aportar gran calidad a la fuente lumínica que es la fluorescencia t5. Su forma le permite la instalación tanto en vertical como en horizontal.*



Chromed aluminium structure. Diffuser made of silk-screened polycarbonate. — Estructura de aluminio anodizado. Difusor de policarbonato serigrafiado.

Structure · Estructura

● Chrome · Cromo

Diffuser · Difusor

○ White · Blanco

T5 24W

Manhattan T5 63.5

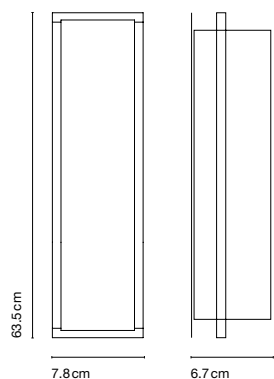

IP44

Its IP44 makes the collection Manhattan T5 particularly suitable for use in bathroom or outdoor. — *La colección Manhattan T5 tiene un índice de protección IP44 especialmente indicado para instalación en baños o exterior.*



MANHATTAN

Joan Gaspar, 1996

MANHATTAN combines a rectangular metal structure with a curved opal glass, which creates a light with a certain minimalist style and basic geometric shapes that works perfectly in series. This lamp is very versatile as it adapts to any space. It is specially recommended for areas of high circulation. — *MANHATTAN combina una estructura rectangular de metal con un cristal curvado blanco para crear una luminaria con cierto estilo minimalista y racional que funciona muy bien en serie. Esta lámpara es muy versátil ya que se adapta a todo tipo de espacios. Es especialmente recomendable su instalación en zonas de circulación.*

Structure of silver grey painted metal, matte chromed frame. Diffuser of engraved and glossy curved opal glass. — Estructura de metal pintado de gris plata y marco cromado mate. Difusor de cristal curvado blanco grabado y satinado.

Structure · Estructura

● Matte chrome · Cromo mate

Diffuser · Difusor

○ White · Blanco

Manhattan 50 □

○ 2x E27 42W HSGSA/C/UB

☐ 2x 15W E27 FBT

Manhattan 50 PL

☐ 2G11 36W

Manhattan 50 / 50 PL

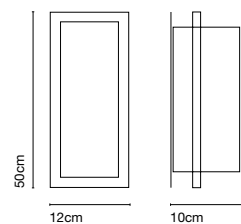

BETA

Marset Team, 1996

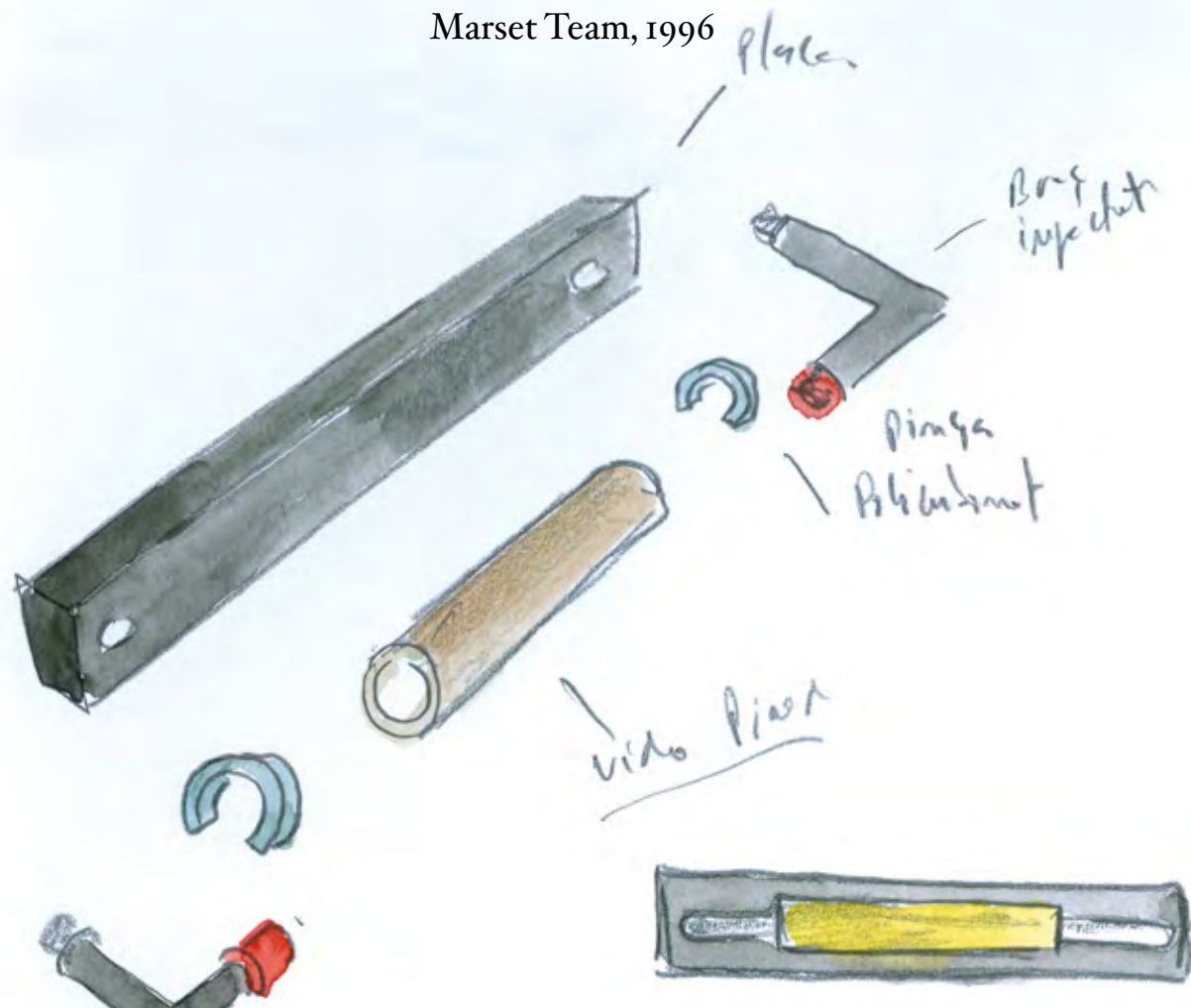

This wall lamp is exceptionally practical. With a minimalist look, its pure halo lights without dazzling. At the same time its design integrates perfectly into the surrounding environment. The screen-printed glass of the diffuser provides the light with an intense quality, thanks also to the halogen bulb inside. — *Este aplique de pared es excepcionalmente funcional. De estética minimalista, su halo de luz de gran calidad ilumina sin estridencias al mismo tiempo que su diseño se integra perfectamente en el entorno en el que se sitúa. El cristal serigrafado de su difusor proporciona una luz de gran calidad gracias también a la bombilla halógena que lo aloja.*



Chromed iron structure. Arms in zamac. Diffuser made of screen-printed glass. — Estructura de hierro cromado. Brazos en zamac. Difusor de cristal serigrafiado.

Structure - Estructura

- Chrome - Cromo
- Matte chrome - Cromo mate

Diffuser - Difusor

- White - Blanco

Beta 2

→ R7s 114mm 120W ECO

Beta 60

→ 2x R7s 114mm 120W ECO

Beta 2

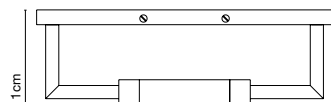
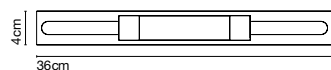

Beta 60

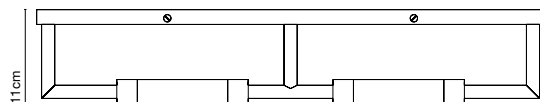
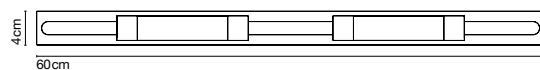

ESPEJITO, ESPEJITO...

Joan Gaspar, 2005

vide buyat
Polian bonet
botella

A magnifying mirror with built-in light and approved for use in bathrooms (IP44). It can be positioned at any angle, thanks to an integral ball and socket joint. The light from its diffuser, a white opal glass globe, subtly illuminates the perimeter of the mirror, creating a warm, pleasant atmosphere. There is also a basic version with the opal glass globe, the light of the ESPEJITO, a perfect partner to get a great lighting in a bathroom area. — *Espejo de aumento iluminado, está homologado para su uso en baños (IP44) y permite orientarlo en el grado deseado gracias a una rótula. La luz de su difusor, un globo de cristal opal blanco, ilumina el perímetro del espejo de forma sutil creando un ambiente cálido y agradable. Existe también una versión básica con el globo de cristal opal, la luz del espejito, perfecta compañera para conseguir la mejor iluminación en el cuarto de baño.*



Opal glass diffuser. Magnifying mirror surrounded by a translucent polycarbonate frame. — *Difusor de cristal opal. Espejo de aumento rodeado por un marco de policarbonato translúcido.*

○ White · Blanco

⚡ G9 48W ECO

Luz Espejito

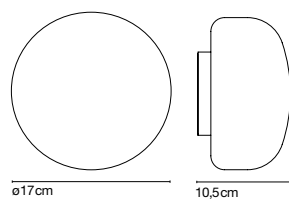

Espejito, espejito...

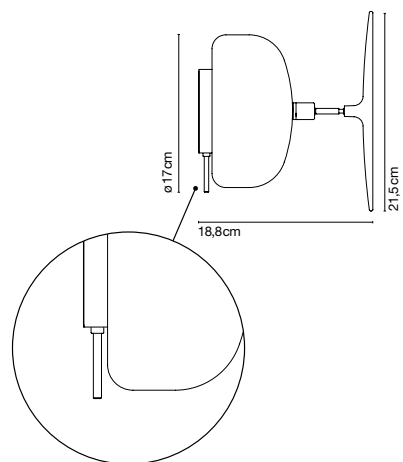

Built-in switch
Interruptor incorporado



IP44





**OUTDOOR
LAMPS**

**LÁMPARAS
DE EXTERIOR**

CALA

IP65

Joan Gaspar, 2012



Creating a warm, comfortable indoor atmosphere in an outdoor space. This is the aim of CALA, a highly decorative light with a structure which draws on the simplicity of metal café tables or the classic painter's trestle. The rotary moulded polyethylene shade is enclosed in a zipped Textilene sleeve which filters the light and gives it a texture rich in nuances.

IP65 rated, it is available in suspension, table and floor version. — *Crear un ambiente confortable y cálido en un espacio exterior. Este es el objetivo de CALA, una lámpara con fuerte carga decorativa y cuya estructura bebe de la sencillez de las mesas metálicas de bar o los clásicos caballetes de pintor. La pantalla de polietileno rotomoldeado está envuelta por una funda de textilene con cremallera que tamiza la luz y le confiere una textura rica en matices. Con un IP65, la familia CALA está disponible en tres versiones: suspensión, sobremesa y pie.*



Structure in painted iron or iroko wood. A rotary moulded polyethylene shade is enclosed in a zipped textile sleeve.
 — **Estructura de metal o de madera iroko. Pantalla de polipropileno rotomoldeado con una funda de textilene en marrón o blanco.**

Structure · Estructura

- Grey · Gris
- Dark iroko · Iroko oscuro

Shade · Pantalla

- White · Blanco
- Brown · Marrón

2x E27 FBT 18W

Cala 140 IP65

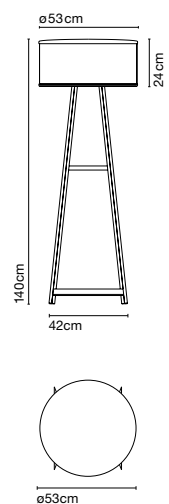

Cala S IP65

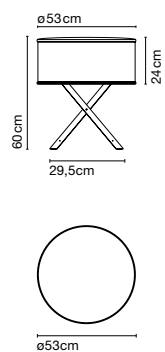

Cala Susp. IP65

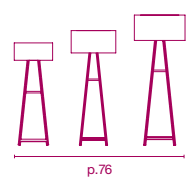
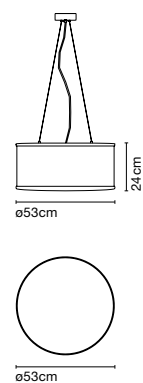

Range · Colección

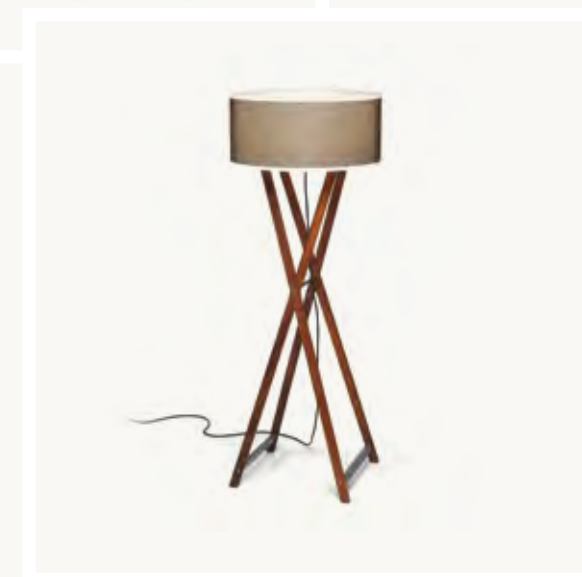
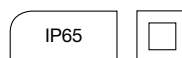





A highly decorative light with a structure which draws on the simplicity of metal café tables or the classic painter's trestle. — *Una lámpara con fuerte carga decorativa y cuya estructura bebe de la sencillez de las mesas metálicas de bar o los clásicos caballetes de pintor.*

LAB

Francesc Rifé, 2012

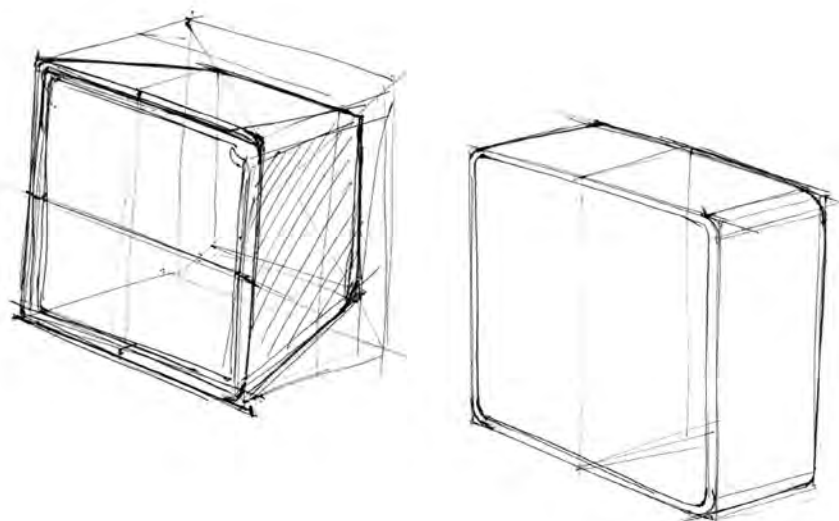

Sober, architectural, functional... LAB is a wall lamp for outdoor use which either blends into a space or stands out in it, thanks to the different materials which can be used in the front panel: Stone, iroko wood and lacquered aluminium in white, black or grey.

This LED lighting system can take a leading role if the material of the front panel is different from the wall, or else merge into it.

While it works on its own, it has enough personality to create multiple lighting compositions. Classed IP65, it also features the option of including signage. — *Sobrio, arquitectónico, funcional... LAB es un aplique de pared para exterior que se integra o destaca en el espacio gracias a los diferentes materiales que pueden utilizarse en el frontal: piedra, madera de iroko, aluminio lacado blanco, gris o negro.*

Este sistema de iluminación con LED puede adoptar protagonismo si el material de su frontal es distinto al muro, o por el contrario, integrarse en él. Aunque funciona independientemente, tiene la suficiente personalidad como para crear múltiples composiciones lumínicas. Con un IP65, también ofrece la posibilidad de incluir señalética.



Structure made of injected aluminium with frontal lids in metal, wood or stone, to be chosen. — Estructura de aluminio inyectado con tapas frontales en metal, madera o piedra, según elección.

Structure · Estructura

- White · Blanco
- Grey · Gris
- Black · Negro

Lid · Tapa

- White · Blanco
- Grey · Gris
- Black · Negro
- Dark iroko · Iroko oscuro
- Light iroko · Iroko claro
- Stone · Piedra

Lab 1

LED 3W 700mA 95lm
(included · incluido)

Lab 2

2x LED 3W 700mA 95lm
(included · incluido)

Lab 1

Lab 2

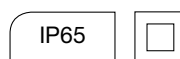
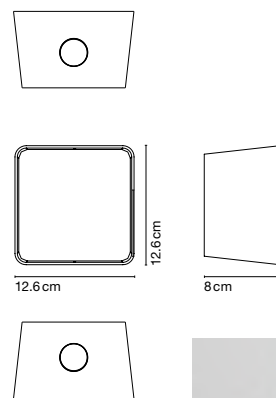
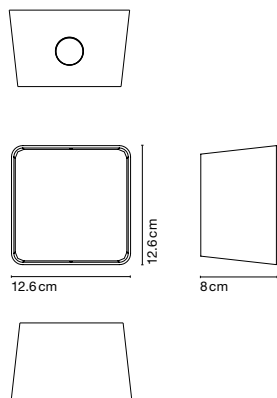



LAB is a wall lamp for outdoor use which either blends into a space or stands out in it, thanks to the different materials which can be used in the front panel: Stone, iroko wood and lacquered aluminium in white, black or grey. — *LAB es un aplique de pared para exterior que se integra o destaca en el espacio gracias a los diferentes materiales que pueden utilizarse en el frontal: piedra, madera de iroko, aluminio lacado blanco, gris o negro.*





TXL

Joan Gaspar, 2007



Designed to illuminate gardens and terraces, TXL emits an extremely warm light, just like an indoor lamp. Tough and impressive, the floor version sits on a slate base which supports a voluminous shade made in fibre-glass coating with a plastic material. The pendant version stands out for its lightness and is suitable for illuminating outdoor tables. — *Pensada para iluminar jardines y terrazas, TXL emite una luz de gran calidez como si de una lámpara de interior se tratara. Resistente y colosal, la versión de pie se asienta sobre una losa de pizarra que sostiene una pantalla de gran volumen realizada en fibra de vidrio recubierta con material de plástico. La versión de suspensión destaca por su ligereza y resulta idónea para iluminar mesas de exterior.*



Cast iron base with slate, and metallic stem, both with stainless cataphoresis treatment. Shade made of textilene ribbons. Diffuser in white acid etched glass. — Base de fundición de hierro con piedra de pizarra, y fuste de metal; ambos con tratamiento antioxidante de cataforesis. Pantalla de cintas de textilene. Difusor de cristal blanco al ácido.

Structure - Estructura

● Grey - Gris

Shade - Pantalla

○ White - Blanco

TXL Susp.70 / TXL 205

💡 2x E27 FBT 23W

TXL Susp. 58 / TXL 170

💡 3x E14 FBT 11W

TXL Susp. 70

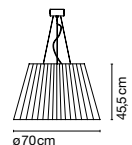

TXL Susp. 58

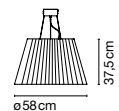

TXL 205

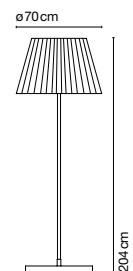

TXL 170

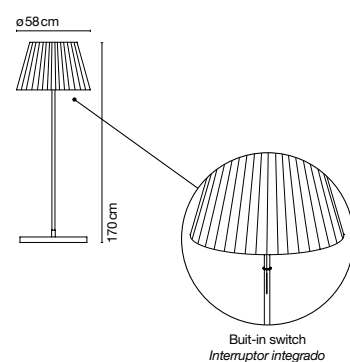

Built-in switch
Interruptor integrado

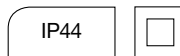









SOHO

Joan Gaspar, 2010

SOHO is presented as a statement, in recognition of the merits of the lamps traditionally used in markets, taverns and cafeterias. After studying different volumes, proportions and materials, new uses and lighting effects have emerged. Through the use of rotary moulded polyethylene, large sizes can be obtained. A methacrylate diffuser produces an evenly distributed light quality. In the translucent white version, the whole structure emits ambient light. — *SOHO se presenta como un alegato. Es un reconocimiento a los méritos de esa lámpara empleada tradicionalmente en mercados, tabernas y cafeterías. Tras reflexionar entorno a volúmenes, proporciones y materiales han surgido nuevos usos y efectos lumínicos. El empleo de polietileno rotomoldeado permite una pieza de gran tamaño. Un difusor de metacrilato procura una excelente luz, homogéneamente tamizada. En la versión translúcida blanca, todo el cuerpo se convierte en emisor de luz ambiente.*

Shade in rotary moulded polyethylene. Methacrylate opal diffuser.
— **Pantalla de polietileno rotomoldeado. Difusor de metacrilato opal.**

- White · Blanco (Ral 9003)
- Stone grey · Gris piedra (Ral 7039)
- Black · Negro (Ral 9005)

- Soho 57 IP44
- T5-C 22W+40W
- T5-C 40W

- Soho 112 IP44
- 8x T5 24W

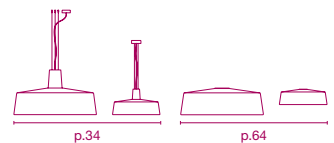
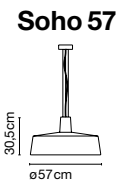
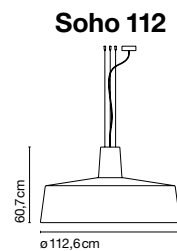

Range · Colección

dimmer

IP44



SOHO is suitable for illuminating porches, gardens and terraces or open-air dining areas. — *SOHO es idónea para iluminar porches, jardines y terrazas o comedores al aire libre.*

DUNA

Antonio Miró, 2006



In the search for the essence of lighting, DUNA is based on the idea of the torches which our forefathers used to brighten their existence. This outdoor fixture has a special ball and socket joint which makes it a flexible and extremely useful lamp. Rotating 360°, it can be pointed in any direction. Its flowerpot-style base is filled with sand which gives it a style particularly suited approach to gardens and terraces. The methacrylate shade is available in white or red with a white interior. — *En la búsqueda de la esencia de la luz, DUNA se basa en las antorchas que iluminaban las épocas de nuestros lejanos antepasados. Esta lámpara de exterior tiene un especial sistema de rótula que la convierte en una lámpara flexible y extremadamente útil ya que puede dirigirse en cualquier dirección con una rotación de 360°. Su base parecida a una maceta está rellena de arena lo que le confiere una estética especialmente adecuada para jardines y terrazas. La pantalla de metacrilato está disponible en blanco y rojo con su interior blanco.*



Aluminium spinning base with sand inside. Aluminium stem.
 Diffuser in methacrylate, red or white, with the inside in white.
 — Base de aluminio repulsado con arena en su interior. Fuste de aluminio. Difusor de metacrilato, rojo o blanco, con el interior en blanco.

Structure - Estructura

● Black - Negro

Shade - Pantalla

● White - Blanco

● Red - Rojo

⦿ 2x E27 53W HSGSA/C/UB

⦿ 2x 15W E27 FBT

Duna

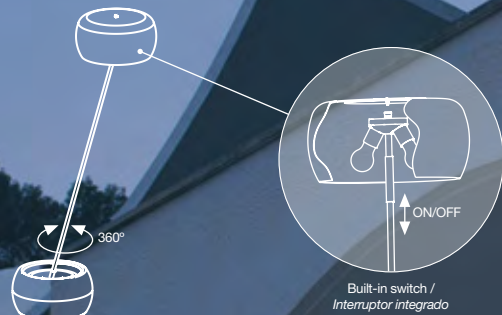

IP23



NAGY

Joan Verdugo, 2006

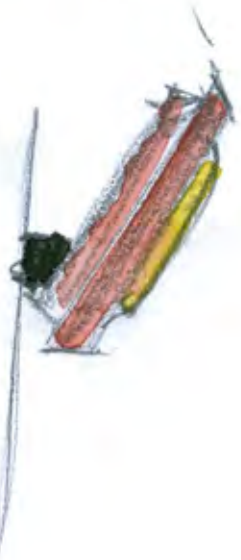
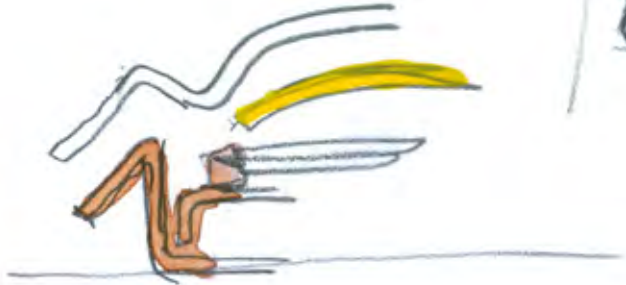

This is a capsule of light in injected polycarbonate with a pressure seal set off by extruded aluminium poles facilitating use at different heights. The capsule is available in a range of transparent colours: anthracite, blue, orange and green. — *Es una cápsula de luz en policarbonato inyectado con cierre estanco que se complementa con unos postes de extrusión de aluminio para su aplicación en distintas alturas. Está disponible en varios colores translúcidos: antracita, azul, naranja y verde.*



Wall bracket in ASA plastic resin. Transparent injected polycarbonate diffuser in various colours. Extruded aluminium poles in different heights. — *Soporte de pared en plástico ASA. Difusor de policarbonato inyectado transparente en varios colores. Postes de extrusión de aluminio de distintas alturas.*

- Anthracite · Antracita
- Blue · Azul
- Orange · Naranja
- Green · Verde

2G11 18W

Nagy

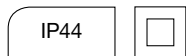
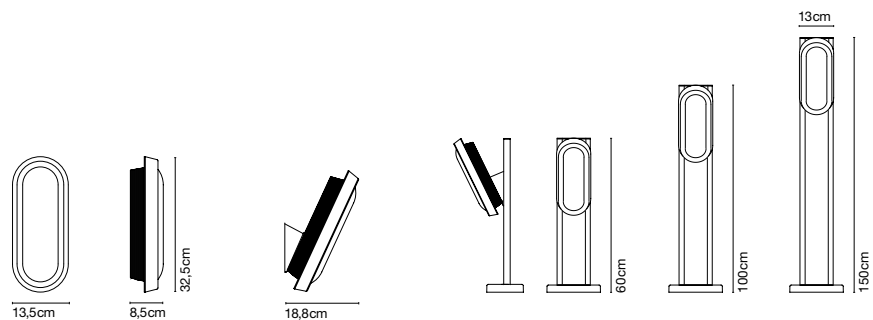



***ARCHITECTURAL
LIGHTING***

***ILUMINACIÓN
ARQUITECTURAL***



NEÓN DE LUZ

Joan Gaspar, 2004



NEÓN DE LUZ marks an inflexion point in the conventional fluorescent systems as it abandons the coldness that distinguishes fluorescent lighting by adding chrome to a transparent polycarbonate structure: a polycarbonate conduit with subtle lit coloured strips and a polycarbonate film which gives the light and product a much finer quality. As a novelty, a new version is presented with an inner aluminium reflector available with LED technology or high efficient fluorescence T5. NEÓN DE LUZ is a very versatile lamp, highly recommendable for places that require continuous lighting due to its low consumption. — *NEÓN DE LUZ se desmarca de las propuestas convencionales de sistemas fluorescentes ya que abandona la frialdad que caracteriza a este tipo de luz fluorescente añadiendo cromatismo a una estructura de policarbonato transparente: se compone de un perfil de policarbonato con unas varillas de color sutilmente iluminadas y una película de policarbonato serigrafado que confiere mucha más calidad a la iluminación y al producto. Como novedad, se presenta una versión con reflector de aluminio interior disponible con tecnología LED o fluorescencia T5 de alto rendimiento. NEÓN DE LUZ es una lámpara de gran versatilidad, muy recomendable para lugares que necesiten de una iluminación continua gracias a su bajo consumo.*



Modular fluorescent system consisting of polycarbonate profile with reflectors inside. Chromed zamac brackets. Reactance box in white polycarbonate or placed inside a metallic tube. — Sistema modular fluorescente compuesto de un perfil de policarbonato con reflectores en su interior. Soportes en zamac cromado. Caja de reactancia en policarbonato blanco o alojada en el interior de un tubo metálico.

- Transparent · Transparente
- Red · Rojo
- Aluminium · Aluminio
- Yellow · Amarillo
- Blue · Azul

Neón de Luz NL - A

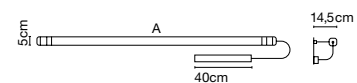

A	Tube	LED
64,5 cm	T5 24W	LED 14,4W
94,5 cm	T5 39W	LED 21,6W
124,5 cm	T5 49W	LED 28,8W
154,5 cm	T5 54W	LED 28,8W

Neón de Luz 2-A

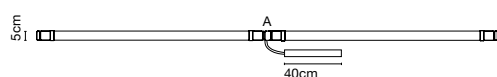

A	Tube	LED
189 cm	2x T5 39W	LED 21,6W
309 cm	2x T5 49W	LED 28,8W
249 cm	2x T5 54W	LED 28,8W

Joint Kit NL-A · Kit Unión NL-A

Neón de Luz NL - S < 1,5m



Neón de Luz NL - S > 1,5m

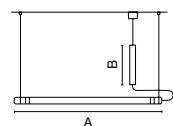

A	B	Tube	LED
94,5 cm	32 cm	T5 39W	LED 14,4W
154,5 cm	32 cm	T5 49W	LED 21,6W
124,5 cm	32 cm	T5 54W	LED 28,8W
154,5 cm	40 cm	T5 80W	LED 28,8W

Neón de Luz 2 < 1,5m

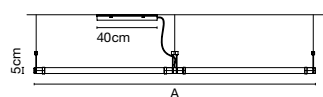

Neón de Luz 2 > 1,5m

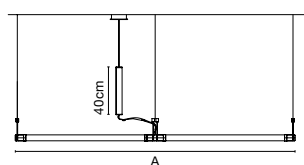

A	Tube	LED
189 cm	2x T5 39W	LED 21,6W
309 cm	2x T5 49W	LED 28,8W
249 cm	2x T5 54W	LED 28,8W

Joint Kit NL-A · Kit Unión NL-A

DISTRIBUCIÓN POLAR (CD/KLM)

Neón de Luz T5 54W

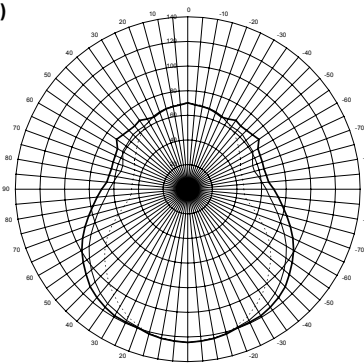

- | -0° [cd/klm]
- | -45° [cd/klm]
- | -90° [cd/klm]



The wall version is available in four sizes (NL-A) depending on the length and wattage of the fluorescent tube, or in double version (2-A) with three sizes. — La versión aplique está disponible en cuatro tamaños (NL-A) en función de la longitud y potencia del tubo fluorescente, o en versión doble (2-A) en tres tamaños.

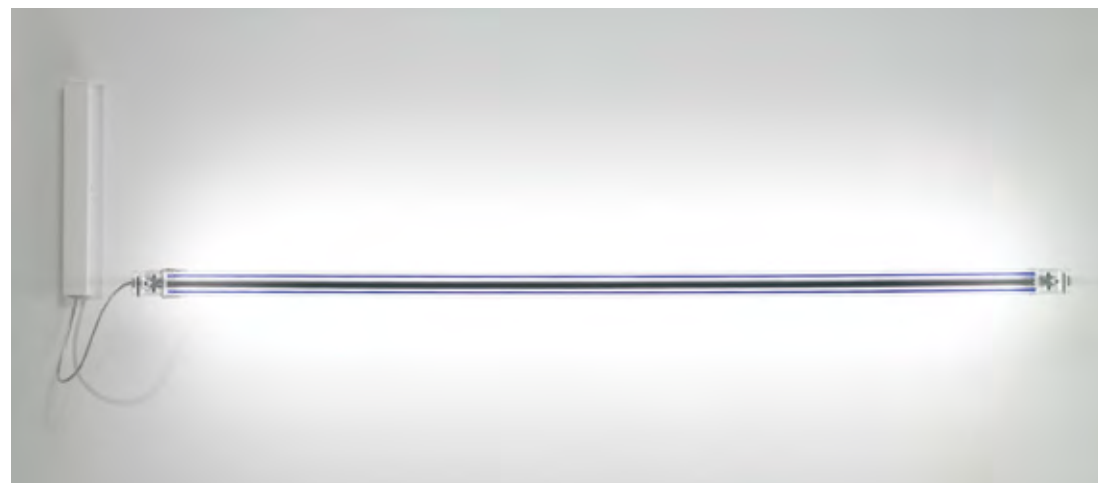

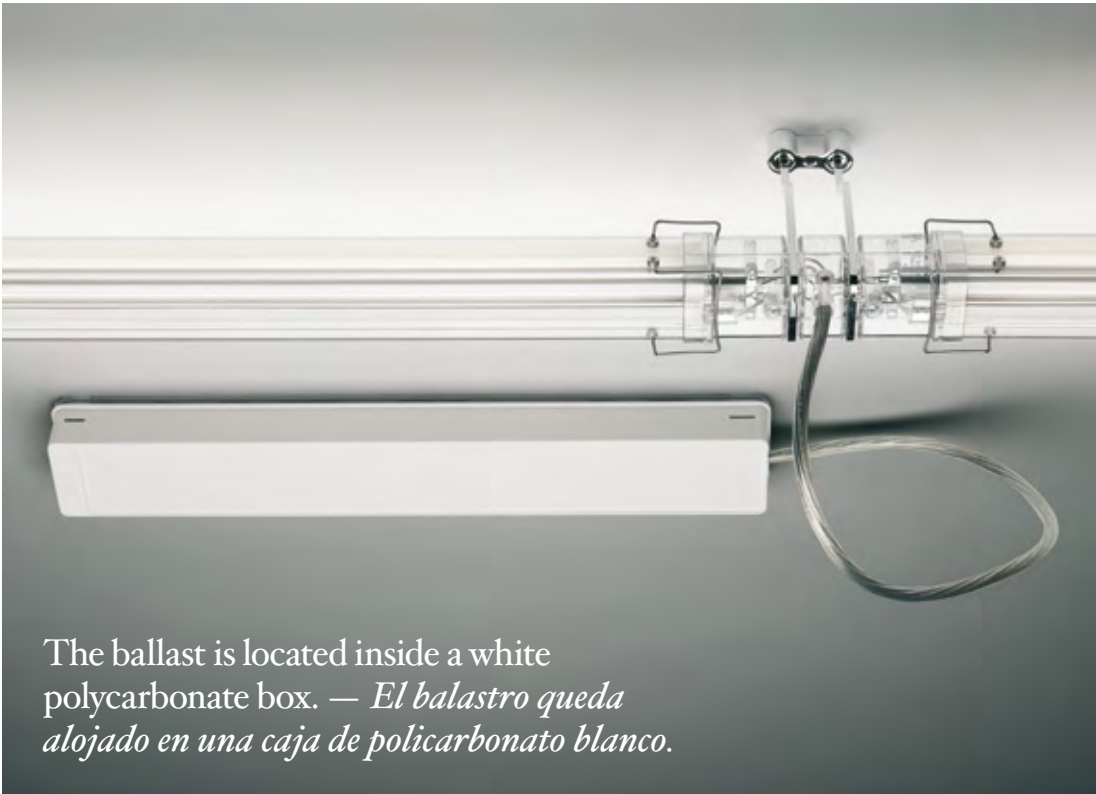

The ballast is located inside a white polycarbonate box. — *El balastro queda alojado en una caja de policarbonato blanco.*



The hanging version, individual (NL-S) or double (NL-2), is available in three sizes.
— *La versión de suspensión, individual (NL-S) o doble (NL-2), se ofrece en tres tamaños.*



NEÓN DE LUZ has a joint connector that allows lighting in pairs, and a support that joins these double systems to create endless lines of light.—*NEÓN DE LUZ* posee un conector que permite la instalación de la luminaria de dos en dos y un soporte para unir estos conjuntos dobles y así crear líneas de luz continuas.

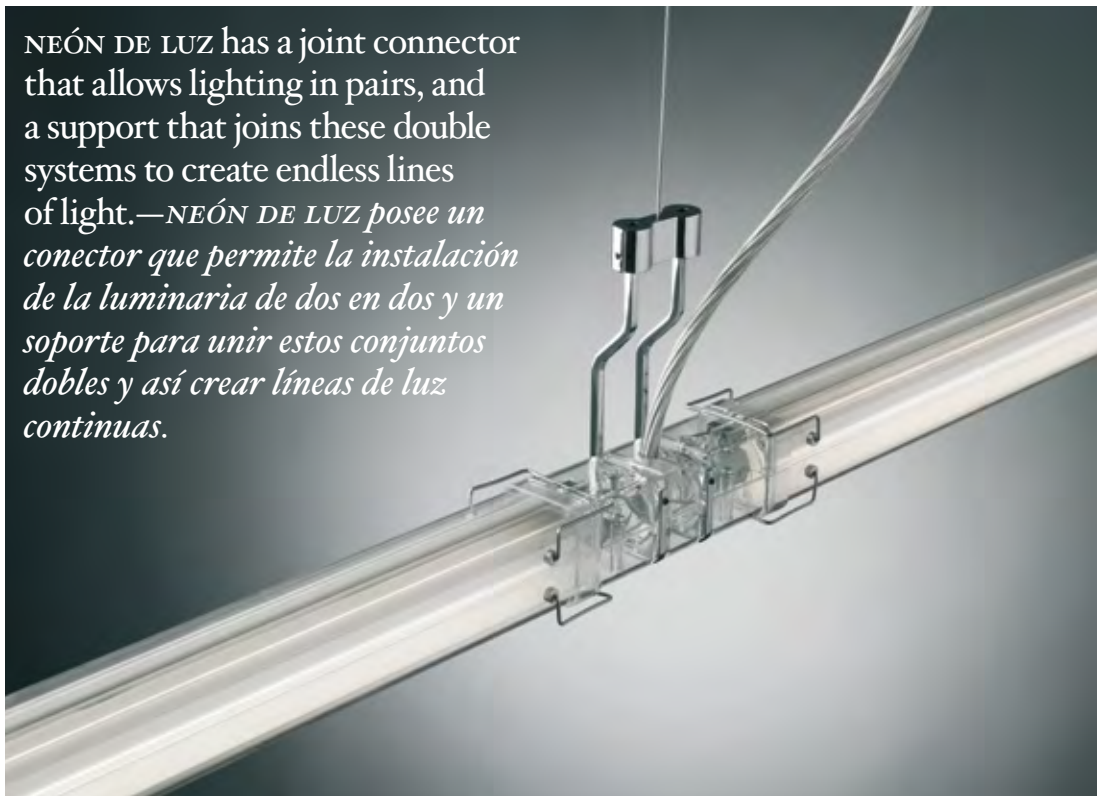

When the distance from the ceiling to the lamp is less than 1.5m ($NL-S < 1,5$), the ballast will be installed in the ceiling. When the distance is more than 1.5m ($NL-S > 1,5$), the ballast will remain suspended inside a tube. — *Cuando la distancia del techo a la luminaria es inferior a 1,5m ($NL-S < 1,5$), el balastro está instalado en un cajetín en el techo. Si la distancia es superior a 1,5m ($NL-S > 1,5$), el balastro queda suspendido dentro de un tubo metálico.*



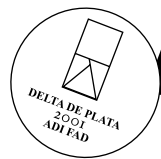

ATLAS

Joan Gaspar, 2000

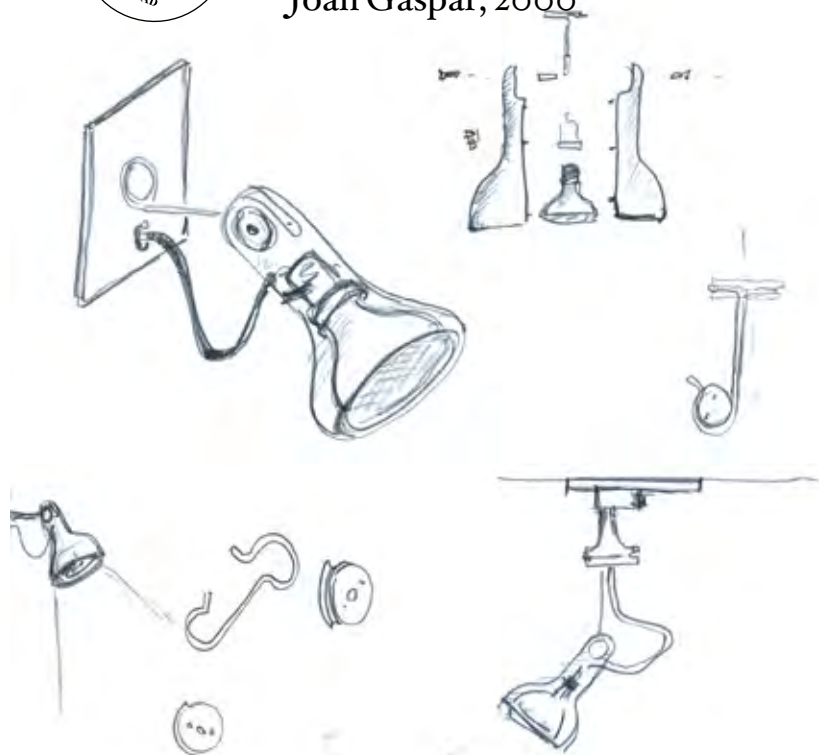

ATLAS transforms a common bulb into a spotlight, enveloping it following its outline. Taking its nudity as the starting point, it dresses the bulb up with a transparent suit that also gives the lamp the added benefit of lightness.

ATLAS is a directional spotlight made of transparent polycarbonate and a polyamide base. There are different versions: suspended and wall or ceiling. It can be grouped in bases of 2 and 3 units, and it is suitable to be installed on track. — *ATLAS convierte la bombilla de uso común en un foco, tras enfundarla siguiendo su contorno. Tomando su desnudez como punto de partida, la viste con un traje transparente que además tiene la virtud de conferirle ligereza.*

Fabricado en policarbonato transparente y una base de poliamida, ATLAS es un foco orientable que se comercializa en diferentes versiones: de suspensión y de pared o techo. Puede agruparse en bases de 2 y 3 unidades o instalarse en un carril.



Transparent polycarbonate shade that envelopes the light source. Stainless steel and teflon joint. Base made of white polyamide. — *Difusor de policarbonato transparente que envuelve la bombilla. Rótula de acero inoxidable y teflón. Base de poliamida blanca.*

⊙ Transparent · Transparente

Atlas

■ E27 PAR30 75W

□ E27 LED PAR30 12W 30° 2800K 2300cd

Atlas QR111

■ QR111 G53 50W 12v

Atlas Mini

■ GU10 ES63 50W

Atlas

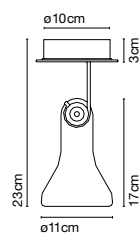

Atlas QR111

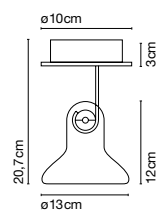

Atlas Mini

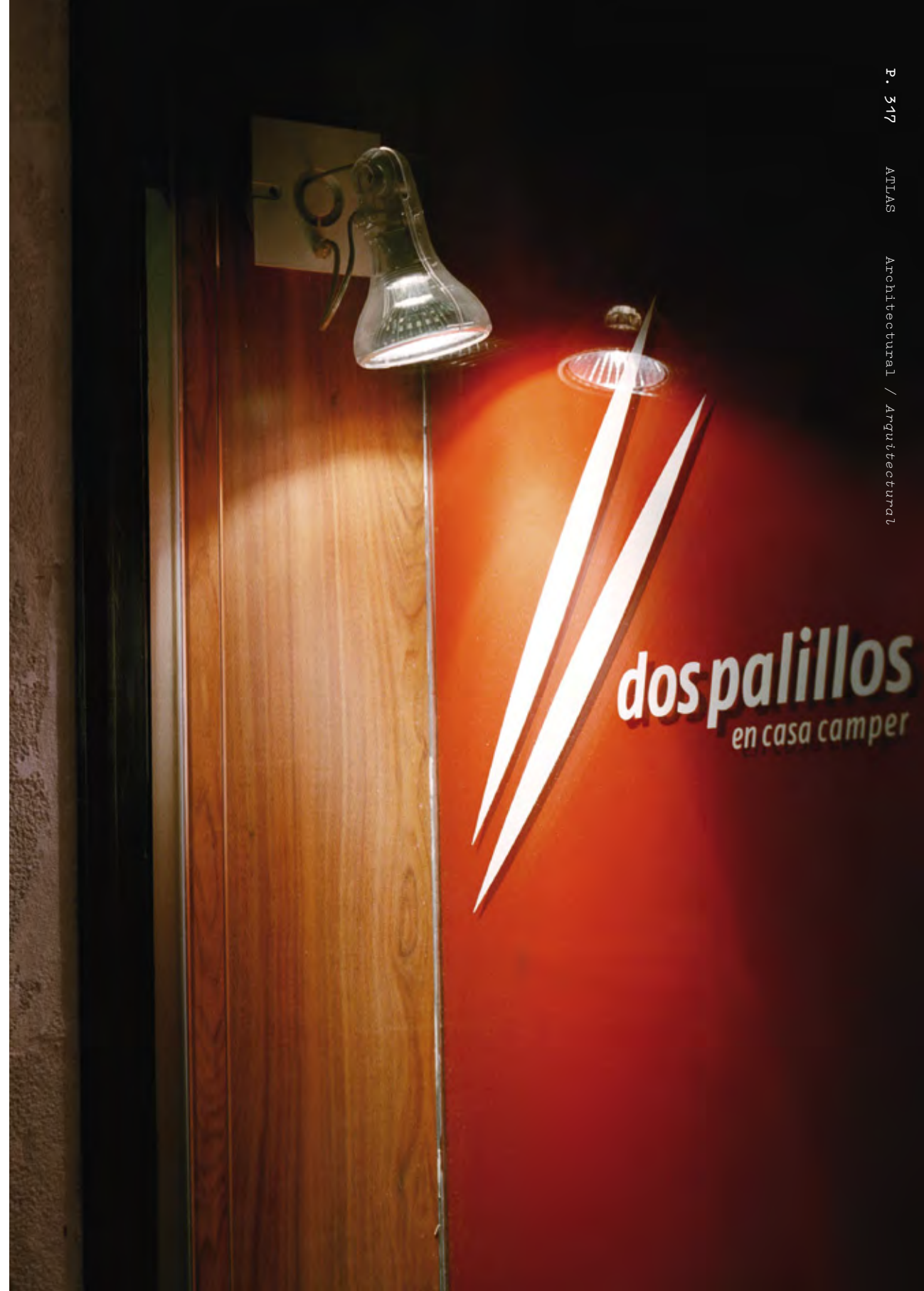
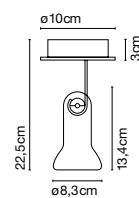



There are excellent light bulbs with LED technology that perfectly fit the ATLAS.
— *Existen excelentes bombillas con tecnología LED que se adaptan perfectamente al ATLAS.*



Base 2



25 cm

Base 3

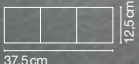

37,5 cm

12,5 cm

ATLAS AD – Track adaptor / Adaptador a raíl



Track adaptor / Adaptador a raíl

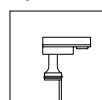

Atlas Ad

- E27 PAR30 75W
- E27 LED PAR30 12W 30°
2800K 2300cd

Atlas QR111 Ad

- ☞ QR111 G53 12V 50W

Atlas 111H Ad

- ☞ BRITE SPOT ES111H GX10 35W

Track adaptor / Adaptador a raíl

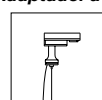

Atlas Susp. Ad

- E27 PAR30 75W
- E27 LED PAR30 12W 30°
2800K 2300cd

Atlas QR111 Susp. Ad

- ☞ QR111 G53 12V 50W



ATLAS MINI 1, 2, 3, 4



Atlas with silver grey metallic support. — Atlas con soporte metálico en gris plata.

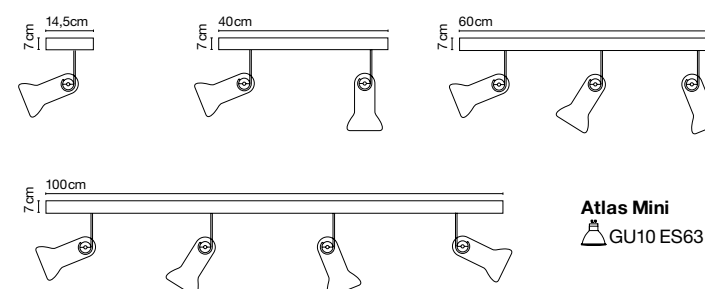

Atlas Mini

- ☞ GU10 ES63 50W



ATLAS – Suspension / Suspensión



Transparent polycarbonate shade that envelops the light source. Canopy made of white polyamide. — *Difusor de policarbonato transparente que envuelve la bombilla. Florón de poliamida blanca.*

Atlas Susp.

- E27 PAR30 75W
- E27 LED PAR30 12W 30°
2800K 2300cd

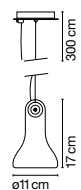

Atlas QR111 Susp.

- QR111 G53 50W 12V

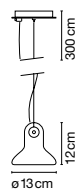

Atlas Mini Susp.

- GU10 ES63 50W

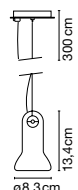



The canopy can be installed partially recessed. — *El florón* se puede instalar también enrasado.

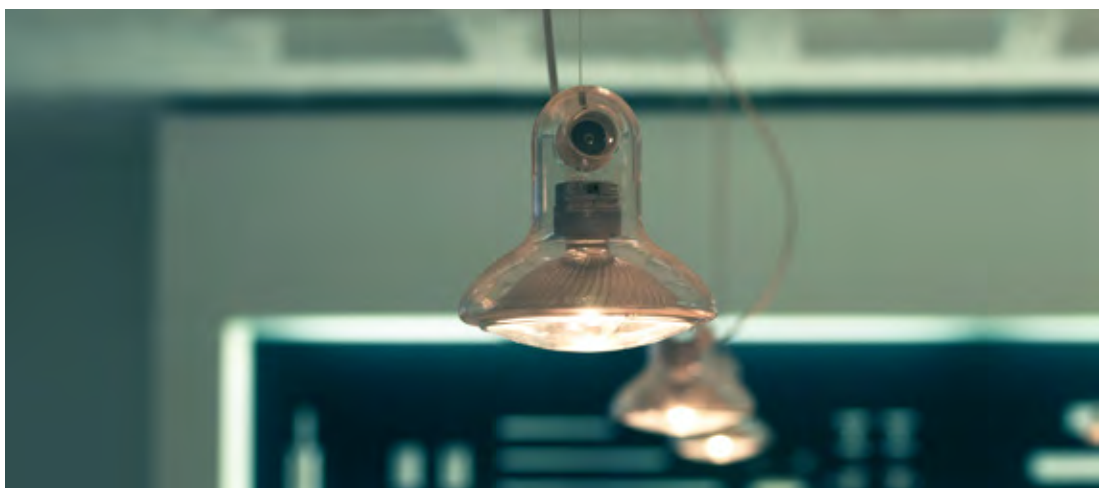

R.AXIS

Joan Gaspar, 2007



R.AXIS is an orientable spotlight collection with a neat visual quality perfect for those projects in which the aesthetics are almost as important as the technical solution.

Available in two diameters (10 and 17cm), lacquered white or black and brushed aluminium. — *R.AXIS es un sistema de focos orientables destinados a aquellos proyectos en los que una estética esmerada resulta tan importante como la solución técnica.*

Disponibile en dos diámetros (10 y 17cm), lacado en blanco o negro y aluminio pulido.



r.axis 17 QR111 G53 50/75/100W 12V

Hoop made of injected and brushed aluminium. The constructive system that allows the orientation of the beam of light consists of an internal support that lodges the light bulb joint to a transparent polycarbonate hoop that provides the turn. — *Aro de aluminio inyectado y cepillado. El sistema constructivo que permite la orientación del haz de luz consta de un soporte interior que aloja la bombilla unido a un aro de policarbonato transparente que proporciona el giro.*

- White · Blanco
- Aluminium · Aluminio
- Black · Negro

Raxis 10

- QR-51-AL GU5,3 12V 50W
- QPAR16 GU-10 230V max.50W
- LED 8W 700mA 30° 629lm
- GU10 LED 8W 35° 2800K 900cd

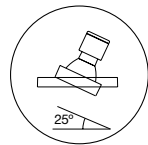
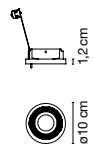

Max. orientation adjustment 25°
Orientable máx. 25°

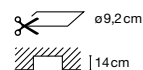

Raxis 10 QR-51-AL
GU5,3 12V 50W

Raxis 17

- QR111 G53 50/75/100W 12V
- CDM-R 111 GX8,5 35/70W
- GU10 LED 15W 24° 2800K 3600cd
- GU10 ES111 230V / 75W / 24°
- QPAR111 GU10 230V/75W

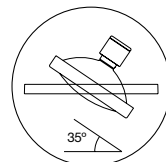
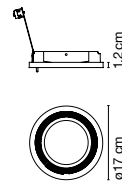

Max. orientation adjustment 35°
Orientable máx. 35°

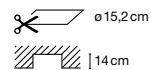

RAXIS 10 is available in an LED version. — *RAXIS 10 está disponible en versión LED.*



Raxis 10 LED 8W 700mA 30° 629lm



SQ.AXIS

Joan Gaspar, 2007

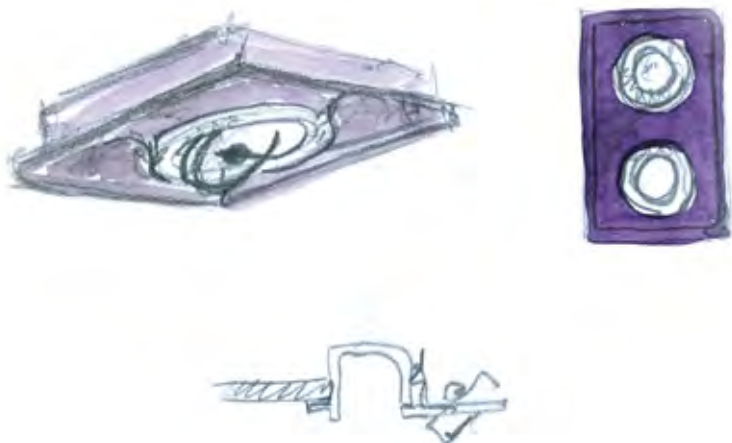

SQ.AXIS is a built-in spotlight system combining the latest technology with a meticulous design in order to meet many lighting engineering requirements. It stands out by way of its up to date aesthetics and its lighting performance, fitting into domestic and business environments perfectly. This collection has been designed to obtain many configurations thanks to the number and type of light source.

This model is available in three sizes. The smallest (SQ.AXIS 10) is fixed, whilst the others have a revolving mechanism which facilitates positioning in any direction. — *SQ.AXIS es un sistema de focos empotrables que conjuga la tecnología más avanzada con un diseño cuidado para resolver múltiples necesidades luminotécnicas. Se destaca por su estética moderna y su rendimiento lumínico, integrándose perfectamente tanto en espacios domésticos como comerciales. Esta colección se ha diseñado para obtener múltiples configuraciones según el número y tipo de fuente de luz.*

Disponible en tres tamaños: El más pequeño (SQ.AXIS 10) es fijo mientras que el resto disponen de un mecanismo de giro que permite orientar la luz en cualquier dirección.





SQ. AXIS 10

Double square framework of transparent polycarbonate which offers a wide range of colours finishings. — *Carcasa cuadrada de doble capa de policarbonato transparente que genera múltiples combinaciones de color.*

- QR-51-AL GU5,3 12V max. 50W
- QPAR16 GU-10 230V max. 50W
- GU10 LED 8W 35° 2800K 3600cd
- BRITE SPOT ES 50 GX-10 35W
- LED 8W 700mA 30° 629lm

SQ. Axis 10

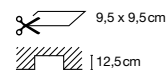
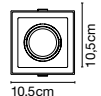

Multiple colour finishings due to the colour combinations of the SQ.AXIS double casing. / *Acabados en múltiples colores debido a la combinación de color de la doble carcasa del SQ.AXIS.*



Black-Transparent · Negro-Transparente



White-Transparent · Blanco-Transparente

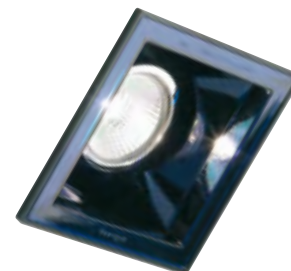

Black-Blue · Negro-Azul



White-Blue · Blanco-Azul



Black-Orange · Negro-Naranja



White-Orange · Blanco-Naranja



Chrome-Transparent · Cromo-Transparente





SQ. AXIS 13



SQ. Axis 13.1 LED 8W 700mA 30° 629 lm

SQ. Axis 13.2 LED 8W 700mA 30° 629 lm

Double square framework of transparent polycarbonate which offers a wide range of colours finishings. On top of it the constructive system that allows the orientation of the beam of light consists of an internal support that lodges the light bulb joint to a transparent polycarbonate hoop that provides the turn.

- QR-51-AL GU5,3 12V max. 50W
- QPAR16 GU-10 230V max. 50W
- GU10 LED 8W 35° 2800K 900cd
- BRITE SPOT ES 50 GX-10 35W
- LED 8W 700mA 30° 629lm

SQ. Axis 13.1

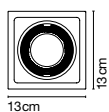

SQ. Axis 13.2

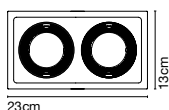

SQ. Axis 13.1

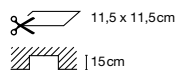

SQ. Axis 13.2

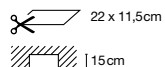

SQ. AXIS 19



SQ. Axis 19.1 QR111 G53 12V Max. 50W

SQ. Axis 19.2 QR111 G53 12V Max. 50W

Carcasa cuadrada de doble capa de policarbonato transparente que genera múltiples combinaciones de color. Encima de esta carcasa, el sistema constructivo que permite la orientación del haz de luz consta de un soporte interior que aloja la bombilla unido a un aro de policarbonato transparente que proporciona el giro.

- QR111 G53 12V Max. 50W
- QPAR111 GU10 230V 75W
- CDM-R 111 GX8,5 35/70W
- GU10 LED 15W 24° 2800K 3600cd
- LED 18W 700mA 30° 1415 lm

SQ. Axis 19.1

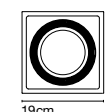

SQ. Axis 19.2

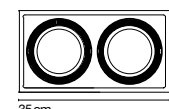

SQ. Axis 19.1

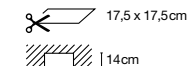

SQ. Axis 19.2



Multiple colour finishings due to the colour combinations of the SQ.AXIS double casing. / *Acabados en múltiples colores debido a la combinación de color de la doble carcasa del SQ.AXIS.*

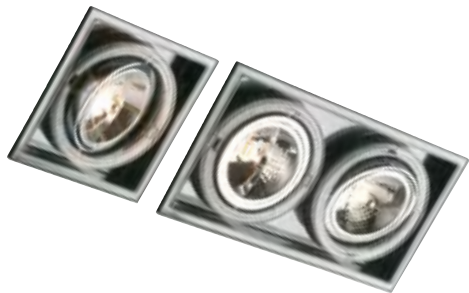

Black-Transparent · Negro-Transparente



White-Transparent · Blanco-Transparente



Black-Blue · Negro-Azul



White-Blue · Blanco-Azul

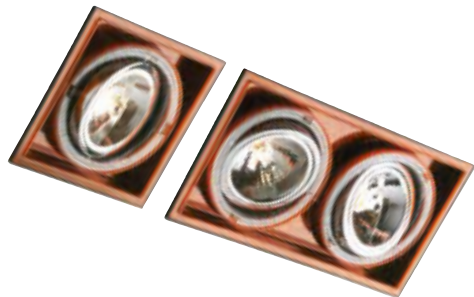

Black-Orange · Negro-Naranja

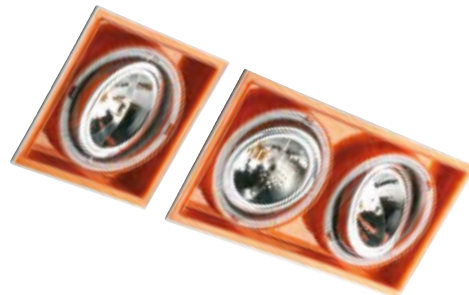

White-Orange · Blanco-Naranja



Chrome-Transparent · Cromo-Transparente



LIN

Rubén Saldaña, 2006



LIN is a direct lighting system by way of an asymmetric reflector. It can be installed in the ceiling or on the wall, on the surface or built-in. LIN is made from anodised aluminium and has a polycarbonate diffuser, which protects the T5 fluorescence. One of its outstanding aspects is the minimal depth – only 3cm.– required to embed it; this means it can also be installed on the surface, as well and in series, thus creating rows of light. — *LIN es un sistema de iluminación directa mediante un reflector asimétrico. Se puede instalar en techos y paredes, empotrado o en superficie. Está producido en aluminio anodizado y con un difusor de policarbonato que protege la fuente de luz, fluorescencia T5. Uno de los aspectos más relevantes es su reducida profundidad de empotramiento de tan sólo 3cm, con la posibilidad de instalarlo también en superficie y en repetición, creando líneas de luz.*

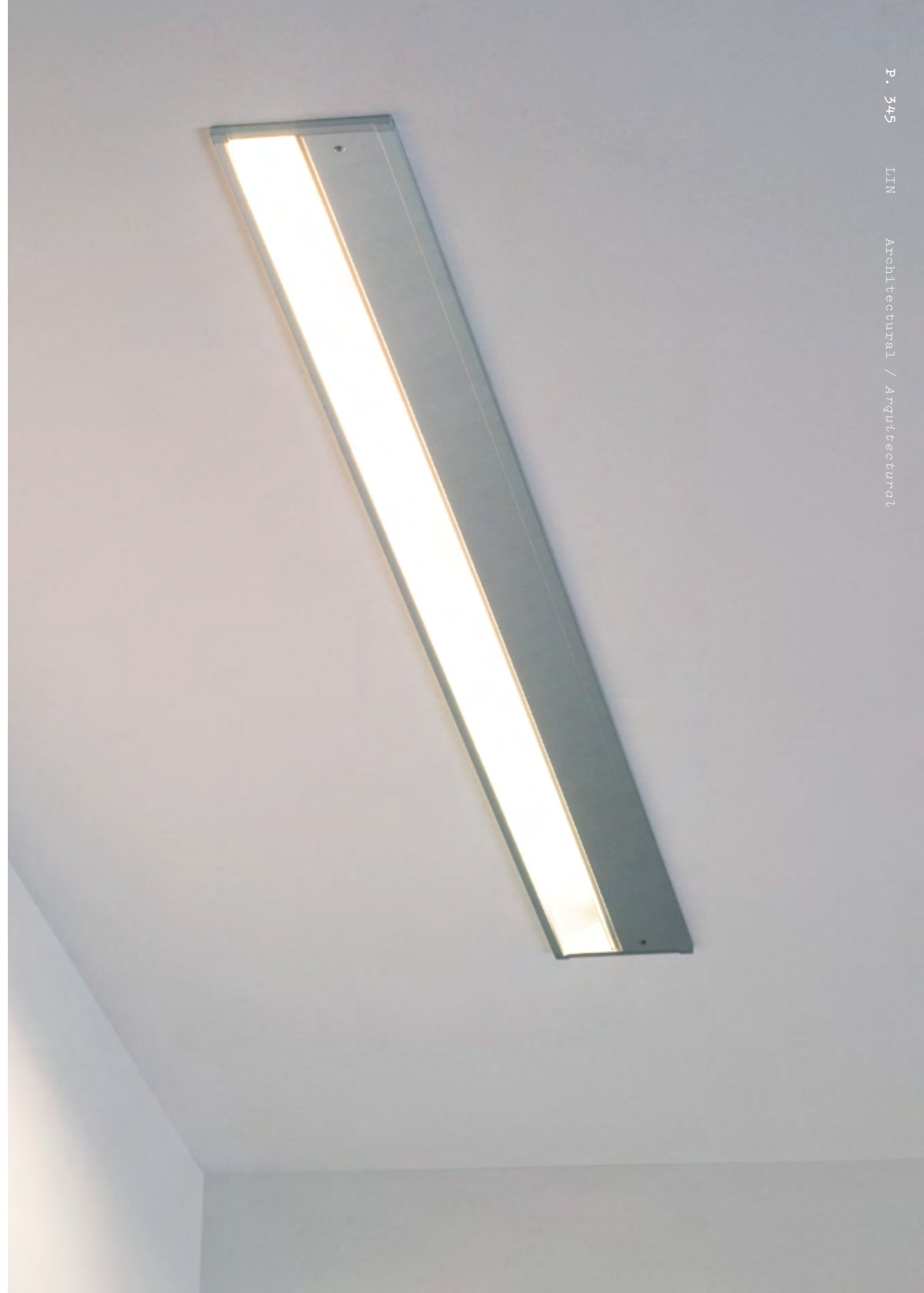

Structure made in extruded, anodized aluminium. Diffuser in transparent polycarbonate. — Estructura en extrusion de aluminio anodizado. Difusor de policarbonato transparente.

* Kit de instalación necesario para su colocación empotrada en cualquier tipo de techo y en pared de ladrillo o cemento. Para pared de pladur o madera no es necesario el kit. When installing Lin recessed in any kind of ceiling or in concrete/brick wall, a special kit is required. This is not necessary when installing on plaster or wooden walls.

Structure · Estructura

● Aluminium · Aluminio

Diffuser · Difusor

○ Transparent · Transparente



A		
17,5cm	T5 4W	16,5 x 9,5cm
33cm	T5 8W	31,5 x 9,5cm
59cm	T5 24W	57,5 x 9,5cm
89cm	T5 39W	87,5 x 9,5cm
119cm	T5 54W	117,5 x 9,5cm
149cm	T5 49W	147,5 x 9,5cm
149cm	T580W	147,5 x 9,5cm

Range of positions · Variedad de posiciones

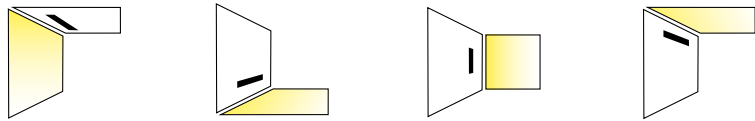

LIN T5 80W 230V

POLAR DISTRIBUTION · DISTRIBUCIÓN POLAR

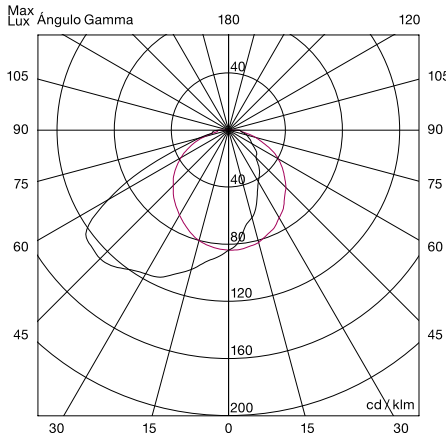

BEAM · HAZ

H[m]	D[m]	Max Lux	Med Lux	Alpha=20.6°+59.7°	G=45.0
1.00	2.47	560	129		
2.00	4.93	140	32		
3.00	7.40	62	14		
4.00	9.86	35	8		
5.00	12.33	22	5		

H[m]	D[m]	Max Lux	Med Lux	Beta=52.2°+54.8°	G=45.0
1.00	3.83	560	129		
2.00	7.66	140	32		
3.00	11.49	62	14		
4.00	15.32	35	8		
5.00	19.15	22	5		

Lin only requires 3cm of minimal depth to be embedded. In case of surface installation, its projection is also minimum: 3cm. — *Lin sólo requiere 3cm de profundidad para empotrarse. En caso de su instalación en superficie, su proyección es también mínima: 3 cm.*



The transparent polycarbonate diffuser protects the light source and the reflector from the dust keeping the light quality. — *El difusor en policarbonato transparente protege la fuente de luz y el reflector del polvo manteniendo así la calidad lumínica.*





COLOURS & FINISHINGS — COLORES Y ACABADOS

	FINISHINGS	ACABADOS	FINITION	OBERFLÄCHENFARBE
	Aluminium	Aluminio	Aluminium	Aluminium
	Anthracite	Antracita	Anthracite	Anthrazit
	Beige	Beige	Beige	Beige
	Black	Negro	Noir	Schwarz
	Blue	Azul	Bleu	Blau
	Brown	Marrón	Marron	Braun
	Chocolate	Chocolate	Chocolat	Schokolade
	Chrome	Cromo	Chromé	Chrom
	Dark iroko	Iroko oscuro	Iroko foncé	Iroko dunkel
	Gold	Oro	Or	Gold
	Green	Verde	Vert	Grün
	Grey	Gris	Gris	Grau
	Grey brown	Gris marrón	Gris brun	Graubraun
	Light iroko	Iroko claro	Iroko clair	Iroko hell
	Matte aluminium	Aluminio mate	Aluminium mat	Aluminium matt
	Matte chrome	Cromo mate	Chromé mat	Chrom matt
	Moss grey	Gris musgo	Gris mousse	Moosgrau
	Natural	Crudo	Natural	Natur
	Oak	Roble	Chêne	Eiche
	Off-white	Blanco roto	Blanc cassé	Gebrochenes weiß
	Orange	Naranja	Orange	Orange
	Pearl White	Blanco perla	Blanc perlé	Perlweiß
	Pink	Rosa	Rose	Rosa
	Red	Rojo	Rouge	Rot
	Sand	Arena	Sable	Sand
	Silk grey	Gris seda	Gris soie	Seidengrau
	Silver grey	Gris plata	Gris argent	Silbergrau
	Stone	Piedra	Pierre	Stein
	Stone grey	Gris piedra	Gris pierre	Steingrau
	Terracotta	Terracota	Terre cuite	Terrakotta
	Tobacco	Tabaco	Tabac	Tabak
	Transparent	Transparente	Transparent	Transparent
	Turquoise blue	Azul turquesa	Bleu Turquoise	Türkisblau
	Umбра grey	Gris sombra	Gris terre d'ombre	Umbragrau
	White	Blanco	Blanc	Weiß
	White linen	Lino blanco	Lin blanc	Leinen weiß
	Yellow	Amarillo	Jaune	Gelb

SYMBOLS — SÍMBOLOS



Basic insulation plus second insulation or both replaced by reinforced insulation. Earthing excluded. — *Aislamiento básico más aislamiento secundario o ambos sustituidos por un aislamiento reforzado. Toma de tierra excluida.*



Very low safety supply voltage; not to be used at over 12V (at 50Hz). Earthing excluded. — *Alimentación de seguridad realizada a bajo voltaje. No debe usarse a más de 12V (a 50 Hz). Toma tierra: excluida.*



All products are manufactured according to the set safety and electromagnetism standards of Europe: EN 60598-1, EN 60598-2-1 and marked CE. — *Todos los productos están fabricados siguiendo las normas de seguridad y electromagnetismo de Europa: EN 60598-1, EN 60598-2-1 y marcado CE.*

Marsset products possess the following certificates: — Los productos de Marsset poseen los certificados siguientes:



www.marset.com

MARSET ILUMINACIÓN S.A.

Factory & Headquarters

Alfonso XII 429-431
08918 Badalona (Spain)
T +34 934 600 107
F +34 934 601 089
info@marset.com

Barcelona Showroom

Santaló 56 Interior
08021 Barcelona (Spain)
T: +34 932 005 726
press@marset.com

Marset USA

20 West 22nd Street - Suite 912
New York, NY 10010
T +1 646 727 4250
F +1 646 304 6959
marsetusa@marset.com

